

***Pioneer***

**STEREO DOUBLE CASSETTE DECK**

**CT-W208R**

**Operating Instructions**

Thank you for buying this Pioneer product. Please read through these operating instructions so you will know how to operate your unit properly. After you have finished reading the instructions, keep them in a safe place for future reference.

In some countries or regions, the shape of the power plug and power outlet may sometimes differ from that shown in the explanatory drawings. However, the method of connecting and operating the unit is the same.

**WARNING:** TO PREVENT FIRE OR SHOCK HAZARD, DO NOT EXPOSE THIS APPLIANCE TO RAIN OR MOISTURE.

## IMPORTANT NOTICE [For U.S. model]

The serial number for this equipment is located on the rear panel. Please write this serial number on your enclosed warranty card and keep it in a secure area. This is for your security.

*This product complies with the Low Voltage Directive (73/23/EEC), EMC Directives (89/336/EEC, 92/31/EEC) and CE Marking Directive (93/68/EEC).*

## IMPORTANT



The lightning flash with arrowhead symbol, within an equilateral triangle, is intended to alert the user to the presence of uninsulated "dangerous voltage" within the product's enclosure that may be of sufficient magnitude to constitute a risk of electric shock to persons.

### CAUTION

**RISK OF ELECTRIC SHOCK  
DO NOT OPEN**

**CAUTION:**  
TO PREVENT THE RISK OF ELECTRIC SHOCK, DO NOT REMOVE COVER (OR BACK). NO USER-SERVICEABLE PARTS INSIDE. REFER SERVICING TO QUALIFIED SERVICE PERSONNEL.



The exclamation point within an equilateral triangle is intended to alert the user to the presence of important operating and maintenance (servicing) instructions in the literature accompanying the appliance.

## IMPORTANT

### FOR USE IN THE UNITED KINGDOM

The wires in this mains lead are coloured in accordance with the following code :

**Blue** : Neutral

**Brown** : Live

If the plug provided is unsuitable for your socket outlets, the plug must be cut off and a suitable plug fitted.

The cut-off plug should be disposed of and must not be inserted into any 13 amp socket as this can result in electric shock. The plug or adaptor or the distribution panel should be provided with 5 amp fuse. As the colours of the wires in the mains lead of this appliance may not correspond with coloured markings identifying the terminals in your plug, proceed as follows :

The wire which is coloured blue must be connected to the terminal which is marked with the letter N or coloured black.

The wire which is coloured brown must be connected to the terminal which is marked with the letter L or coloured red.

Do not connect either wire to the earth terminal of a three pin plug.

#### NOTE

After replacing or changing a fuse, the fuse cover in the plug must be replaced with a fuse cover which corresponds to the colour of the insert in the base of the plug or the word that is embossed on the base of the plug, and the appliance must not be used without a fuse cover. If lost replacement fuse covers can be obtained from: your dealer.

Only 5 A fuses approved by B.S.I. or A.S.T.A to B.S. 1362 should be used.

This equipment has been tested and found to comply with the limits for a Class B digital device, pursuant to Part 15 of the FCC Rules. These limits are designed to provide reasonable protection against harmful interference in a residential installation. This equipment generates, uses, and can radiate radio frequency energy and, if not installed and used in accordance with the instructions, may cause harmful interference to radio communications. However, there is no guarantee that interference will not occur in a particular installation. If this equipment does cause harmful interference to radio or television reception, which can be determined by turning the equipment off and on, the user is encouraged to try to correct the interference by one or more of the following measures:

- Reorient or relocate the receiving antenna.
- Increase the separation between the equipment and receiver.
- Connect the equipment into an outlet on a circuit different from that to which the receiver is connected.
- Consult the dealer or an experienced radio/TV technician for help.

### Information to User

Alteration or modifications carried out without appropriate authorization may invalidate the user's right to operate the equipment.

# IMPORTANT SAFETY INSTRUCTIONS

**READ INSTRUCTIONS** — All the safety and operating instructions should be read before the product is operated.

**RETAIN INSTRUCTIONS** — The safety and operating instructions should be retained for future reference.

**HEED WARNINGS** — All warnings on the product and in the operating instructions should be adhered to.

**FOLLOW INSTRUCTIONS** — All operating and use instructions should be followed.

**CLEANING** — Unplug this product from the wall outlet before cleaning. The product should be cleaned only with a polishing cloth or a soft dry cloth. Never clean with furniture wax, benzene, insecticides or other volatile liquids since they may corrode the cabinet.

**ATTACHMENTS** — Do not use attachments not recommended by the product manufacturer as they may cause hazards.

**WATER AND MOISTURE** — Do not use this product near water — for example, near a bathtub, wash bowl, kitchen sink, or laundry tub; in a wet basement; or near a swimming pool; and the like.

**ACCESSORIES** — Do not place this product on an unstable cart, stand, tripod, bracket, or table. The product may fall, causing serious injury to a child or adult, and serious damage to the product. Use only with a cart, stand, tripod, bracket, or table recommended by the manufacturer, or sold with the product. Any mounting of the product should follow the manufacturer's instructions, and should use a mounting accessory recommended by the manufacturer.

**CART** — A product and cart combination should be moved with care. Quick stops, excessive force, and uneven surfaces may cause the product



and cart combination to overturn.

**VENTILATION** — Slots and openings in the cabinet are provided for ventilation and to ensure reliable operation of the product and to protect it from overheating, and these openings must not be blocked or covered. The openings should never be blocked by placing the product on a bed, sofa, rug, or other similar surface. This product should not be placed in a built-in installation such as a bookcase or rack unless proper ventilation is provided or the manufacturer's instructions have been adhered to.

**POWER SOURCES** — This product should be operated only from the type of power source indicated on the marking label. If you are not sure of the type of power supply to your home, consult your product dealer or local power company.

**LOCATION** — The appliance should be installed in a stable location.

**NONUSE PERIODS** — The power cord of the appliance should be unplugged from the outlet when left un-used for a long period of time.

## GROUNDING OR POLARIZATION

- If this product is equipped with a polarized alternating current line plug (a plug having one blade wider than the other), it will fit into the outlet only one way. This is a safety feature. If you are unable to insert the plug fully into the outlet, try reversing the plug. If the plug should still fail to fit, contact your electrician to replace your obsolete outlet. Do not defeat the safety purpose of the polarized plug.
- If this product is equipped with a three-wire grounding type plug, a plug having a third (grounding) pin, it will only fit into a grounding type power outlet. This is a safety feature. If you are unable to insert the plug into the outlet, contact your electrician to replace your obsolete outlet. Do not defeat the safety purpose of the grounding type plug.

**POWER-CORD PROTECTION** — Power-supply cords should be routed so that they are not likely to be walked on or pinched by items placed upon or against them, paying particular attention to cords at plugs, convenience receptacles, and the point where they exit from the product.

**OUTDOOR ANTENNA GROUNDING** — If an outside antenna or cable system is connected to the product, be sure the antenna or cable system is grounded so as to provide some protection against voltage surges and built-up static charges. Article 810 of the National Electrical Code, ANSI/NFPA 70, provides information with regard to proper grounding of the mast and supporting structure, grounding of the lead-in wire to an antenna discharge unit, size of grounding conductors, location of antenna-discharge unit, connection to grounding electrodes, and requirements for the grounding electrode. See Figure A.

**LIGHTNING** — For added protection for this product during a lightning storm, or when it is left unattended and unused for long periods of time, unplug it from the wall outlet and disconnect the antenna or cable system. This will prevent damage to the product due to lightning and power-line surges.

**POWER LINES** — An outside antenna system should not be located in the vicinity of overhead power lines or other electric light or power circuits, or where it can fall into such power lines or circuits. When installing an outside antenna system, extreme care should be taken to keep from touching such power lines or circuits as contact with them might be fatal.

**OVERLOADING** — Do not overload wall outlets, extension cords, or integral convenience receptacles as this can result in a risk of fire or electric shock.

**OBJECT AND LIQUID ENTRY** — Never push objects of any kind into this product through openings as they may touch dangerous voltage points or short-out parts that could result in a fire or electric shock. Never spill liquid of any kind on the product.

**SERVICING** — Do not attempt to service this product yourself as opening or removing covers may expose you to dangerous voltage or other hazards. Refer all servicing to qualified service personnel.

**DAMAGE REQUIRING SERVICE** — Unplug this product from the wall outlet and refer servicing to qualified service personnel under the following conditions:

- When the power-supply cord or plug is damaged.
- If liquid has been spilled, or objects have fallen into the product.
- If the product has been exposed to rain or water.
- If the product does not operate normally by following the operating instructions. Adjust only those controls that are covered by the operating instructions as an improper adjustment of other controls may result in damage and will often require extensive work by a qualified technician to restore the product to its normal operation.
- If the product has been dropped or damaged in any way.
- When the product exhibits a distinct change in performance — this indicates a need for service.

**REPLACEMENT PARTS** — When replacement parts are required, be sure the service technician has used replacement parts specified by the manufacturer or have the same characteristics as the original part. Unauthorized substitutions may result in fire, electric shock, or other hazards.

**SAFETY CHECK** — Upon completion of any service or repairs to this product, ask the service technician to perform safety checks to determine that the product is in proper operating condition.

**WALL OR CEILING MOUNTING** — The product should not be mounted to a wall or ceiling.

**HEAT** — The product should be situated away from heat sources such as radiators, heat registers, stoves, or other products (including amplifiers) that produce heat.

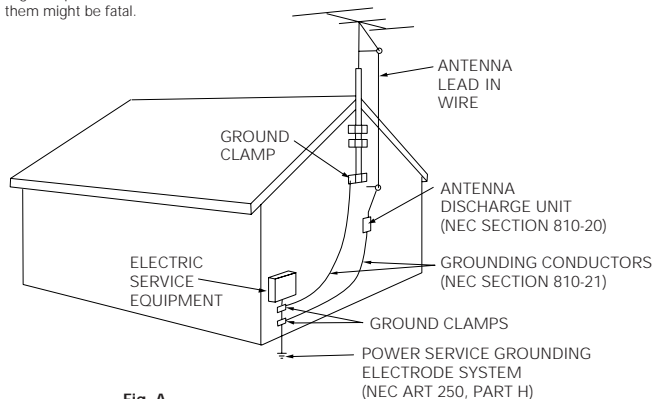

Fig. A

NEC — NATIONAL ELECTRICAL CODE

## CONDENSATION

When the unit is brought into a warm room from previously cold conditions or when the room temperature is suddenly increased, condensation may form inside and the unit may not be able to attain its full performance. To prevent this, allow the unit to stand for about an hour or raise the room temperature gradually.



## We Want You Listening For A Lifetime

### Dear Customer:

Selecting fine audio equipment such as the unit you've just purchased is only the start of your musical enjoyment. Now it's time to consider how you can maximize the fun and excitement your equipment offers. This manufacturer and the Electronic Industries Association's Consumer Electronics Group want you to get the most out of your equipment by playing it at a safe level. One that lets the sound come through loud and clear without annoying blaring or distortion—and, most importantly, without affecting your sensitive hearing.

Sound can be deceiving. Over time your hearing "comfort level" adapts to higher volumes of sound. So what sounds "normal" can actually be loud and harmful to your hearing. Guard against this by setting your equipment at a safe level BEFORE your hearing adapts.

#### To establish a safe level:

- Start your volume control at a low setting.
- Slowly increase the sound until you can hear it comfortably and clearly, and without distortion.

#### Once you have established a comfortable sound level:

- Set the dial and leave it there.

Taking a minute to do this now will help to prevent hearing damage or loss in the future. After all, we want you listening for a lifetime.

Used wisely, your new sound equipment will provide a lifetime of fun and enjoyment. Since hearing damage from loud noise is often undetectable until it is too late, this manufacturer and the Electronic Industries Association's Consumer Electronics Group recommend you avoid prolonged exposure to excessive noise. This list of sound levels is included for your protection.

#### Decibel

Level	Example
30	Quiet library, soft whispers
40	Living room, refrigerator, bedroom away from traffic
50	Light traffic, normal conversation, quiet office
60	Air conditioner at 20 feet, sewing machine
70	Vacuum cleaner, hair dryer, noisy restaurant
80	Average city traffic, garbage disposals, alarm clock at two feet.

#### THE FOLLOWING NOISES CAN BE DANGEROUS UNDER CONSTANT EXPOSURE

90	Subway, motorcycle, truck traffic, lawn mower
100	Garbage truck, chain saw, pneumatic drill
120	Rock band concert in front of speakers, thunderclap
140	Gunshot blast, jet plane
180	Rocket launching pad

Information courtesy of the Deafness Research Foundation.



### POWER-CORD CAUTION

Handle the power cord by the plug. Do not pull out the plug by tugging the cord and never touch the power cord when your hands are wet as this could cause a short circuit or electric shock. Do not place the unit, a piece of furniture, etc., on the power cord, or pinch the cord. Never make a knot in the cord or tie it with other cords. The power cords should be routed in such a way that they are not likely to be stepped on. A damaged power cord can cause a fire or give you an electrical shock. Check the power cord once in a while. When you find it damaged, ask your nearest PIONEER authorized service center or your dealer for a replacement.

## CONTENTS

INSTALLATION .....	4
MAINTENANCE .....	5
HANDLING CASSETTE TAPES .....	6
CONNECTIONS .....	7
FRONT PANEL FACILITIES .....	8
PLAYBACK .....	11
SINGLE PLAYBACK .....	11
BLANK SKIP .....	11
RELAY PLAYBACK .....	12
MUSIC SEARCH .....	13
RECORDING .....	14
RECORDING .....	14
RECORDING MUTE .....	14
ERASING A TAPE .....	14
TAPE COPYING .....	15
TROUBLESHOOTING .....	16
SPECIFICATIONS .....	Back cover

## INSTALLATION

When installing the deck, avoid locations with high temperatures or humidity, and make sure that the deck receives adequate ventilation.

- Do not install the deck in locations subject to direct sunlight, or near a space heater or other heating device, as this may cause damage to the finish or internal parts.
- Malfunctions may also result if the deck is installed in an excessively humid or dusty location. Avoid installing the deck next to kitchen counters or other locations subject to oily smoke or humidity.
- If the deck is placed directly on top of an amplifier, it may pick up humming or other noise. Also, if the amplifier generates a large amount of heat, the deck may malfunction.
- If the deck is located near a television set, it may pick up interference noise, which will be recorded as a whistling sound on the tape. If this happens, move the deck further away from the television set or turn the television set off when operating the deck.
- Do not place a cloth over the deck, or block the ventilation slots in any way. The ventilation slots on this deck are necessary to keep internal parts cool. If they are blocked, the deck may malfunction.

# MAINTENANCE

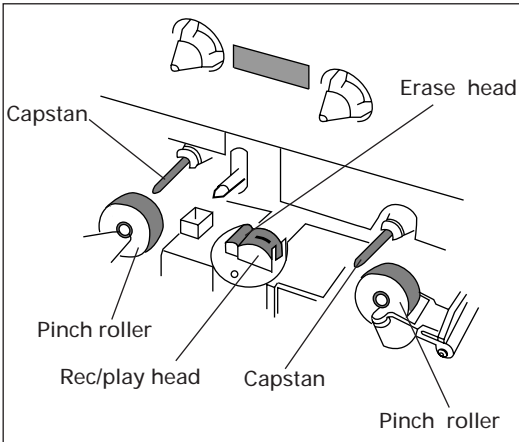

## CLEANING THE HEADS, PINCH ROLLERS AND CAPSTANS

The heads, pinch rollers and capstans are likely to get dirty quite easily. If these parts, particularly the heads, get dirty, the high frequency components of a recording will not be reproduced and the stereo balance will be impaired, resulting in a deterioration of the playback sound. It is therefore recommended that the head section be cleaned regularly.

1. Set the POWER switch to OFF.
2. Press the eject button to open the cassette door.
3. Dip a cleaning swab in cleaning fluid and use it to wipe the heads, capstans and pinch rollers.

### NOTE:

*After cleaning the head section, do not load a tape until the cleaning fluid has dried completely (about two or three minutes).*

## DEMAGNETIZING THE HEADS

After using the cassette deck for a period of time, the heads will become magnetized. The same effect will occur if a magnetized screwdriver, magnet or other magnetized object is brought too close to the heads. When the heads become magnetized, high-frequency sounds will be lost during recording or playback, and interference noise may also occur. The heads should be regularly demagnetized with a head demagnetizer, which can be purchased at most audio stores.

When demagnetizing the heads, make sure that the POWER switch of the cassette deck is set to ON. **However, be sure to turn down the amplifier's volume control to its lower position**, and disconnect any headphones from their headphones jack. For detailed instructions, refer to the operating instructions of the head demagnetizer.

## CLEANING THE FRONT PANEL

Clean the deck regularly with a soft cloth. If the front panel becomes soiled, moisten a soft cloth with a weak solution of neutral detergent (diluted in five to six parts water), wring the cloth well, and wipe the panel clean. Never use volatile cleaners like thinners, benzene or alcohol because they will damage the panel finish.

# HANDLING CASSETTE TAPES

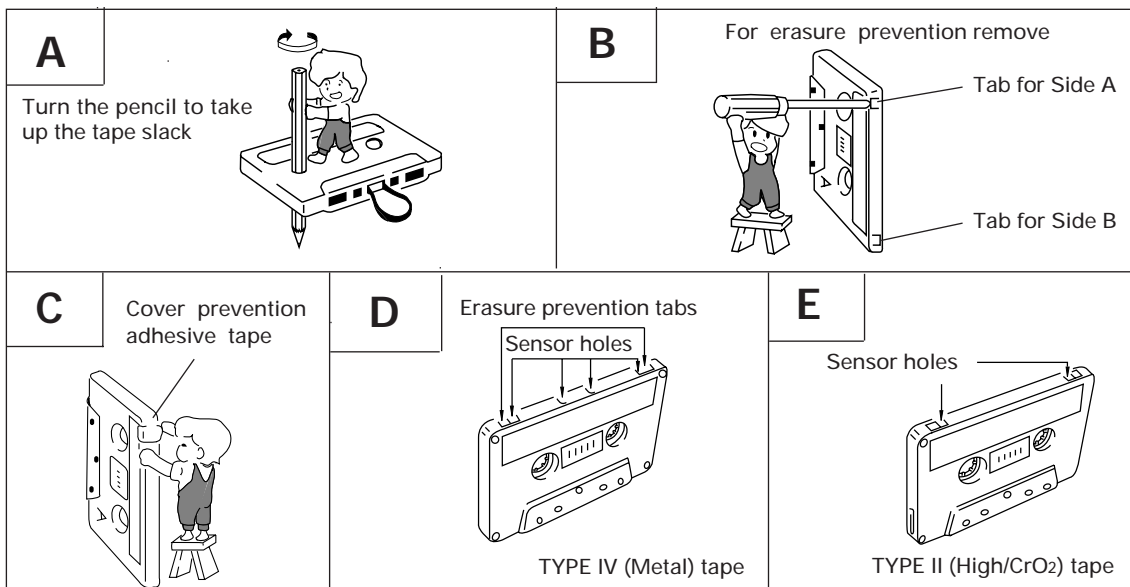

## CHECK CASSETTE BEFORE USE

Check the following items before loading a cassette tape:

### Is the tape loose, or is some of the tape outside the cassette?

If some of the tape is loose or projecting outside the cassette shell, the tape may not load properly between the capstan and pinch roller. This will prevent the tape from operating properly, and may even damage the tape itself. To prevent this, insert a pencil into the reel hole and take up the slack (Fig. A). Some cassette tapes come with a plastic or thick paper stopper to prevent the tape from becoming slack. Remove this stopper when loading the cassette and replace it after using the cassette.

### Are the accidental erasure prevention tabs intact?

These tabs allow you to prevent important recordings from being erased accidentally. When the tab on the cassette shell is broken off (Fig. B), it is not possible to activate the recording function, so valuable recordings will not be erased by mistake.

To rerecord on a cassette whose tab has been broken off, simply stick a piece of doubled adhesive tape over the hole (Fig. C).

When using TYPE IV (Metal) or TYPE II (High/CrO<sub>2</sub>) tapes, be careful not to block the sensor holes with the tape (Fig. D, Fig. E). If the holes are blocked, the automatic tape selector mechanism will not operate correctly.

#### NOTES:

- The accidental erasure prevention tab for each side is the one located on the top left when the side that you want to protect is facing you.
- When breaking off the tab, do not use a magnetized screwdriver.

## AUTOMATIC TAPE SELECTOR FUNCTION

This cassette deck is equipped with an automatic tape selector function which utilizes the sensor holes on the tape cassette to determine the type of tape being used. The deck is then set to match the tape recording bias and equalization.

#### NOTES:

- When using TYPE IV (Metal) tapes, make sure that the tapes have sensor holes.
- Make sure that the sensor holes on the cassette are not blocked; otherwise the tape selector mechanism will not function properly.
- Do not use TYPE III (FeCr) tapes.

## TIPS ON CASSETTE TAPES

### Do not use tapes longer than 90 minutes in length

Because over the C-90 tapes are very thin, they can easily jam in the pinch rollers and capstan, and they often are subject to other problems such as irregular winding.

- Leader tape (which cannot be recorded on) is provided at the beginning of a cassette tape. Let the tape run for about 5 seconds before starting to record, to allow the leader tape to clear the recording head.
- Do not leave a cassette tape exposed to the environment. Store the cassette in its case after use so that dust and dirt do not adhere to the tape, and so the tape will not get slack. Store tapes in a location free from magnetism, dust, dirt, oil, heat and humidity.
- If cassette tapes are irregularly wound, the tape may get jammed in the rollers. This can cause damage to both the tape and the deck. If you are not certain whether the tape is wound evenly, fast forward or rewind the tape from beginning to end, to make sure that the tape is properly wound.

# CONNECTIONS

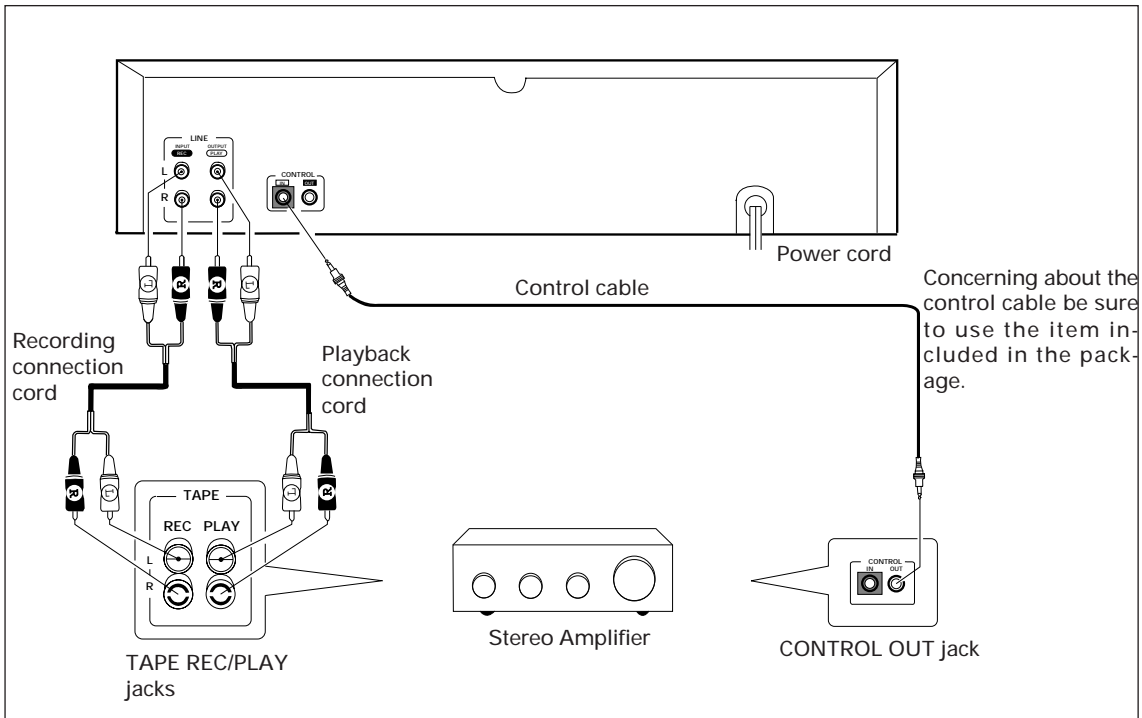

- Before making or changing the connections, switch off the power switch and disconnect the power cord from the AC outlet.
- Read through the operating instructions of the stereo components which you intend to connect to this unit.
- Make sure that all of the connection plugs are inserted securely, as improper connections may generate noise.

## CONNECTING THE RECORDING AND PLAYBACK CORDS

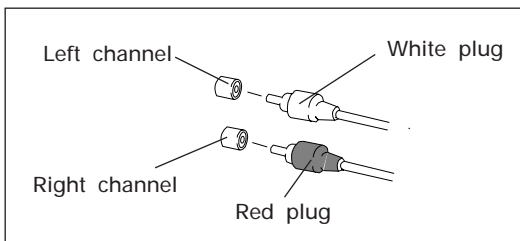

Connect the TAPE jacks of your amplifier to the LINE jacks of the cassette deck. Be sure to connect the REC (INPUT) jacks of the deck to the recording (output) jacks of the amplifier, and the PLAY (OUTPUT) jacks of the deck to the play (input) jacks of the amplifier.

- Connect the plugs properly:
  - Left channel — White plug
  - Right channel — Red plug

## PIONEER SYSTEM REMOTE CONTROL

### CONTROL IN jack

Use the enclosed control cable to connect this jack to the CONTROL OUT jack of another component which bears the  mark (indicating that it is equipped with PIONEER System Remote Control). You will then be able to operate this unit using the Pioneer system remote control unit. If the remote control unit does not have separate buttons for deck I and deck II, or a selection button to choose deck I or deck II, the buttons will only operate deck II. To operate deck I with a remote control unit which was not designed for double deck cassette players, see page 9.

### CONTROL OUT jack

Intermediary jack outputs signals from the CONTROL IN jack of this unit to the input jack of another unit. Connect this jack to the CONTROL IN jack of another component compatible with Pioneer System Remote Control.

#### NOTE:

*Be sure to connect both of the control cable's plugs securely to the CONTROL IN and CONTROL OUT jacks. Do not connect only one end of the cable.*

## CONNECTING THE POWER CORD

Insert the power cord of the cassette deck into the accessory AC outlet of your amplifier, or into a normal household outlet.

# FRONT PANEL FACILITIES

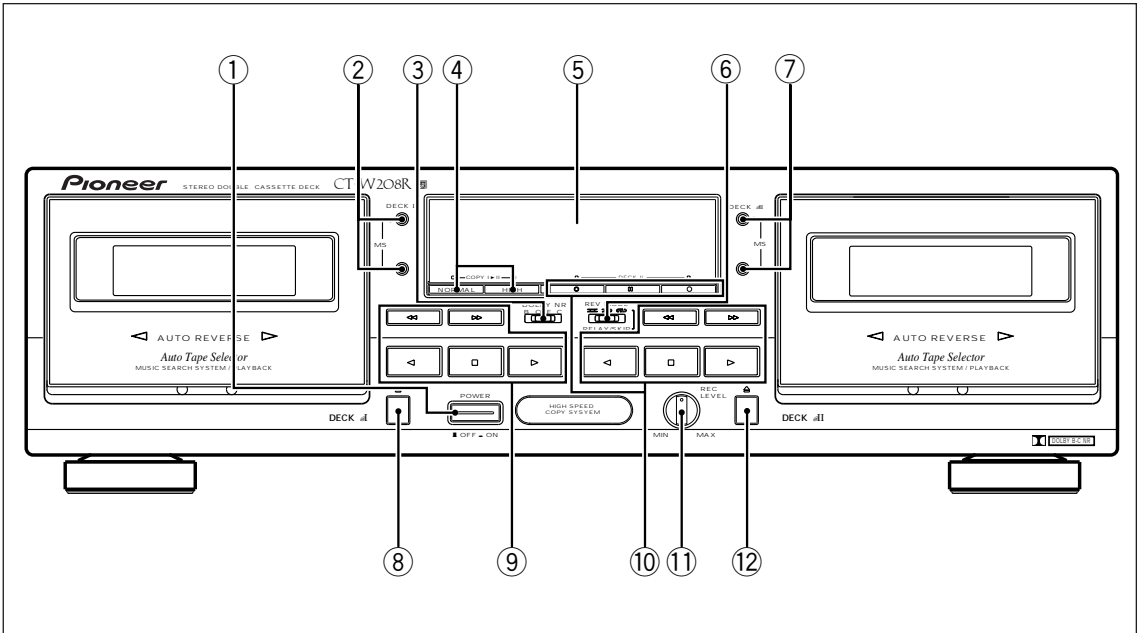

① **POWER switch**

② **DECK I MS(music search) +,- buttons**

③ **DOLBY\* NR switch (B/OFF/C)**

\*

● *Dolby noise reduction and manufactured under license from Dolby Laboratories Licensing Corporation.*

● *"DOLBY", the double-D symbol are trademarks of Dolby Laboratories Licensing Corporation.*

④ **Syncho copy buttons (COPY I ► II)**

NORMAL: Normal speed copy

HIGH : Double speed copy

⑤ **Function display**

⑥ **Reverse mode switch (REV MODE RELAY/SKIP)**

⑦ **DECK II MS(music search) +,- buttons**

⑧ **DECK I eject button (▲)**

- If the tape is moving (playback, tape winding, etc.), press the stop (■) button before pressing this button.

**NOTE:**

*If the power is turned off while the tape is moving, the cassette door may remain locked. In this case, turn the power on before pressing the eject (▲) button.*

⑨ **Deck I operation buttons**

◀ : Reverse playback

▶ : Forward playback

◀◀ : Fast reverse

■ : Stop

▶▶ : Fast forward

⑩ **DECK II operation buttons**

◀ : Reverse playback

▶ : Forward playback

◀◀ : Fast reverse

■ : Stop

▶▶ : Fast forward

○ : Recording mute

|| : Pause

● : Recording

⑪ **Recording level control (REC LEVEL)**

⑫ **DECK II eject button (▲)**

- If the tape is moving (recording, playback, tape winding, etc.), press the stop (■) button before pressing this button.

**NOTE:**

*If the power is turned off while the tape is moving, the cassette door may remain locked. In this case, turn the power on before pressing the eject (▲) button.*



## FRONT PANEL FACILITIES

### REVERSE MODE SWITCH (REV MODE)

There are three settings:

#### One way mode $\rightleftarrows$ position

When the switch is set to this position, playback or recording is performed on one side of the tape only. When the tape reaches the end of the side, it stops automatically (auto stop function).

#### Two way mode $\rightleftarrows$ position

When the switch is set to this position, playback or recording can be performed on both sides of the tape. When the tape reaches the end of the first (forward) side, its direction is automatically reversed, and playback or recording continues on the other (reverse) side. When it reaches the end of the reverse side, the tape stops automatically (auto stop function). If playback or recording is started from the reverse side, the tape will stop when it reaches the end of that side.

#### Repeat mode $\rightleftarrows$ position

When the switch is set to this position for playback, both sides of the tape are played back repeatedly until the stop (■) button is pressed, or until the tape has been replayed 15 times (32 sides playback). If the pause button is pressed to pause the tape, and then playback is restarted, the repeat mode starts over from the beginning, and will play the tape 15 times (32 sides playback).

When the switch is set to this position for recording, both sides are recorded and then the tape stops, as described above for the two way mode.

#### RELAY PLAY/BLANK SKIP

If Deck I and II are loaded with tapes, each tape will be played using relay playback.

### OPERATION OF DECK I WITH A REMOTE CONTROL UNIT NOT DESIGNED FOR DOUBLE DECKS (System remote control)

#### Selecting DECK I

In order to operate DECK I with the remote control unit, adjust the unit as follows: With the power off, press and hold the stop (■) button of DECK I, and turn the power on. Continue to hold the stop (■) button for approximately five seconds. DECK I can now be operated using the remote control unit, but DECK II cannot.

#### Switching to DECK II

To restore remote control operation to DECK II, press the stop (■) button of DECK II while DECK II is in stop mode. DECK II can now be operated using the remote control unit. Remote control operation can be switched back and forth between decks by pressing the stop button of the desired DECK while it is in stop mode.

#### NOTE:

If a power failure or a sudden change in the power supply (caused by lightning, etc.) occurs, the unit is reset to its original state. Only DECK II can be operated by remote control. To restore operation to either deck, repeat the above procedure from the beginning.

### DOLBY NR

#### ■ Dolby NR System

Dolby NR systems are designed to reduce the amount of tape hiss, mainly in the treble components. During recording, the highpitched pianissimo sounds which are most characteristic of audible noise are boosted, and during playback, only these boosted sections are attenuated, so that tape sound is returned to normal. As a result, the noise is attenuated by an amount equal to the boosting in the treble range. The Dolby B-type NR system reduces noise in the treble range, cutting tape hiss and expanding the dynamic range. The Dolby C-type NR system is even more effective in reducing noise, as it reduces noise from the mid-range on.

#### NOTE:

When a tape has been recorded using the Dolby B-type or C-type NR system, make sure that the DOLBY NR switch is set to the same position during playback.

### FUNCTION DISPLAY

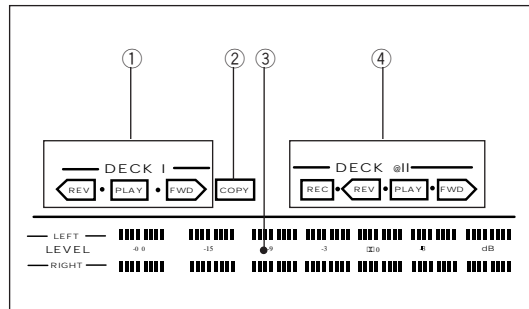

#### ① DECK I tape transport mode indicators

- See page 10.

#### ② Synchro copy indicator (COPY)

Indicator lights steadily : Copying at normal speed.

Indicator flashes : Copying at double speed.

#### ③ Level meter

- The  $\square$  between the "0" and "-3" marks indicates the reference level for the Dolby NR system.

#### ④ DECK II tape transport mode indicators

- See page 10.





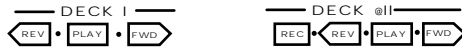





# FRONT PANEL FACILITIES

## TAPE TRANSPORTATION MODE INDICATORS











The indicators shown below indicate the current tape transport status of DECK I or DECK II.

For both DECK I and II  Flashing rapidly

	Forward mode	Reverse mode
Stop	• • FWD	REV • •
Playback	• PLAY • FWD	REV • PLAY •
Fast forward	•  •	 •
Fast reverse	 • FWD	REV • 
Forward music search	 • FWD	REV • 
Reverse music search	 •  • FWD	REV •  • 

DECK II only

 Flashing slowly

	Forward mode	Reverse mode
Playback pause	•  	 
Recording	REC • • FWD	REC REV • •
Recording standby	REC • • 	REC  •
Recording mute	 • FWD	  •

# PLAYBACK

## SINGLE PLAYBACK (Either DECK I or DECK II)

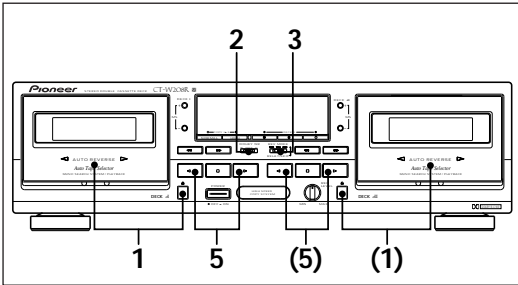

1. Load a prerecorded tape in DECK I or II.
2. Set the DOLBY NR switch.
  - Always set the switch to the same position that was used for recording.
3. Set the REV MODE switch (see page 9).
4. Set the stereo amplifier for tape playback.
5. Press the playback (▶ or ◀) button of either DECK I or II.

### To stop playback temporarily (DECK II only)

Press the pause (⏸) button.

- To resume playback, either press the pause (⏸) button again, or press the playback (▶ or ◀) button.

### To stop playback

Press the stop (■) button.

### NOTE:

When the play button (forward) is pressed during fast forward, the unit will play back in the reverse direction, and then play back in the forward direction. (vice versa for reverse)

**Example:** When ▶ is pressed during fast forward:

Fast forward → stop → Reverse play (0.5 seconds) → stop → Forward play

## BLANK SKIP



This function allows you to skip unrecorded portions of the tape during playback. Set the REV MODE switch to ⏏.

### NOTES:

- When the REV MODE switch is set to the ⏏ position, the relay mode will be selected.
- When this mode is selected, if the tape deck encounters an unrecorded portion of tape more than 15 seconds in length, it will fast forward the tape until it encounters another recorded portion, and resume playback from that point.

# PLAYBACK

## RELAY PLAYBACK

When relay playback mode is selected, continuous playback can be performed. When the tape in the first deck reaches its end and stops, the other deck will automatically begin playback.

1. **Load prerecorded tapes in DECK I and DECK II.**
2. **Set the DOLBY NR switch.**
  - Always set the switch to the same positions that was used for recording.
3. **Set the REV MODE switch to  $\text{↔}$  (See table entitled "PLAYBACK SEQUENCE WITH REV MODE SWITCH SETTING" on this page).**
4. **Set the stereo amplifier for tape playback.**
5. **Press the playback (▶ or ◀) button of the deck that will start to play first.**
  - When the tape in one deck ends, the other deck automatically begins playback.
  - To cancel relay playback, press the stop (■) button.

### NOTES:

- Relay playback can begin from either DECK I or DECK II.
- The tape in the idle deck can be replaced during relay playback mode, allowing many tapes to be played back continuously. This is a convenient feature for parties, background music, etc.
- When this mode is selected, if the deck encounters an unrecorded portion of tape more than 15 seconds in length, it will fast forward the tape until it encounters another recorded portion, and resume playback from that point.

### To stop playback temporarily (Deck II only)

Press the pause (⏸) button.

- To resume playback, either press the pause (⏸) button again, or press the playback (▶ or ◀) button.

### To stop playback

Press the stop (■) button of the operating deck.

## PLAYBACK SEQUENCE WITH REV MODE SWITCH SETTING

The playback sequence depends on the setting of the REV MODE switch and on which playback (▶ or ◀) button is pressed first. The playback sequence for each possible selection is shown below.

\*2 In the repeat ( $\text{↺}$ ) mode, relay playback always begins from the forward direction.

- I ▶ : DECK I forward playback
- I ◀ : DECK I reverse playback
- II ▶ : DECK II forward playback
- II ◀ : DECK II reverse playback
- ∞ : Auto-reverse function
- : Relay

REV MODE switch	Starting playback button	Other deck mode	Playback sequence
$\text{↺}$	DECK I ▶	*2	I▶ ∞   ◀→ II▶ ∞    ◀→ I▶ ∞   ◀→ ... 15 times relay (32 sides playback)
$\text{↺}$	DECK I ◀	*2	I◀ → II▶ ∞    ◀→ I▶ ∞   ◀→ II▶ ... 15 times relay (31 sides playback)
$\text{↺}$	DECK II ▶	*2	II▶ ∞    ◀→ I▶ ∞   ◀→ II▶ ∞    ◀→ ... 15 times relay (32 sides playback)
$\text{↺}$	DECK II ◀	*2	II◀ → I▶ ∞   ◀→ II▶ ∞    ◀→ I▶ ... 15 times relay (31 sides playback)

## MUSIC SEARCH

(Skipping forward or backward to playback a desired selection)

The music search function detects blanks (longer than 4 seconds) between selections, advances the tape in the forward or reverse direction to find the beginning of the desired selection and automatically starts playback.

It can find a selection located up to 15 selections before or after the present position.

### During forward playback

When you wish to locate a future song, press the MS+ button as many times as the number of songs currently being played from the beginning, press the MS- button once. To return to a previously played song, press the MS- button as many times as the number of songs to be skipped, plus one.

### During reverse playback

When you wish to locate a future song, press the MS+ button as many times as the number of songs to be skipped. When you wish to listen to the song currently being played from the beginning, press the MS- button once. To return to a previously played song, press the MS- button as many times as the number of songs to be skipped plus one.

### From the stop mode

Press the MS+ or - button to perform music search as mentioned above.

### Display the number of songs skipped.

The level meter will blink to display the number of songs skipped.

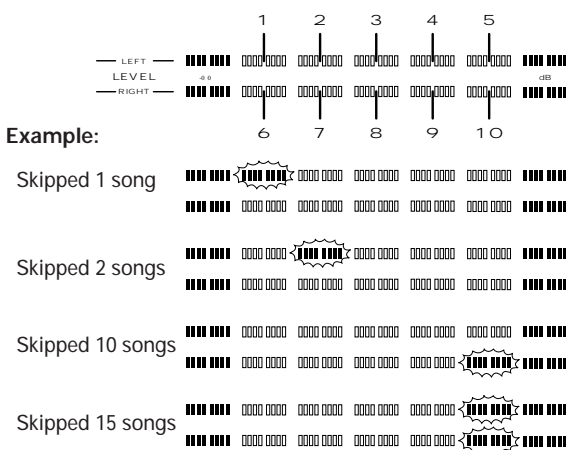

## Selecting songs during skip operations

To change songs to be skipped, press the MS + and MS - buttons during skip operations.

**Example:** When selecting the 5th song by pressing the MS + button in the forward direction:

When MS + is pressed : The 6th song is selected.

When MS - is pressed : The 4th song is selected.

- If the button is pressed more times than the number of selections recorded on the tape, forward search will continue on the opposite side, but reverse search will stop at the tape end.

### NOTES:

In the following circumstances, the music search function may be unable to properly detect blanks between selections; this is not, however, a sign of a malfunction with the unit.

- When using a tape with blanks between selections less than 4 seconds long.
- When listening to tapes with long low-level intervals, like classical music, or with sound breaks several seconds long within selections.
- When listening to recorded conferences or talk shows, where sound is intermittent.
- When using tapes with noise in the blanks between selection.

## How Selections are counted

When starting the music search operation from the middle of a selection and specifying "1st previous selection," playback will return to the beginning of the present selection. To return to selections further back, count one extra selection.

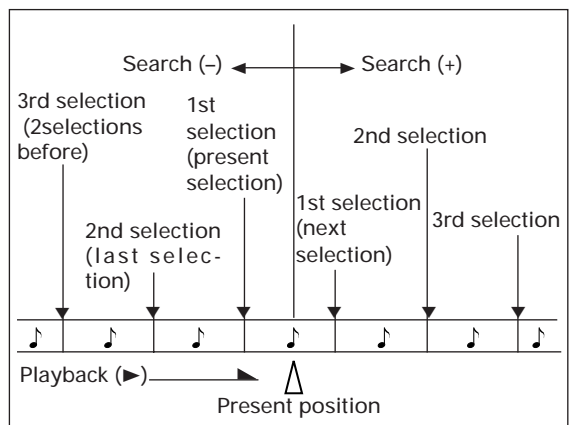

# RECORDING

## RECORDING (Deck II only)

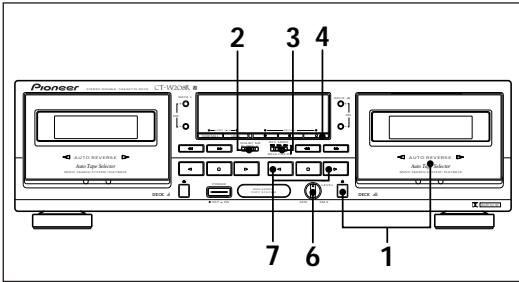

1. Load a tape for recording in Deck II.
2. Set the DOLBY NR switch.
3. Set the REV MODE switch.
  - To record on one side only, set the switch to the  $\square$  position. To record on both sides, set the switch to the  $\square$  position.
4. Press the recording (●) button.
5. Prepare the audio source from which you wish to record. Turn on the stereo amplifier and prepare it for playback of the desired audio source.
6. Adjust the recording level. For details, see "ADJUSTING THE RECORDING LEVEL" below.
7. Press the playback (▶ or ◀) button or the pause (||) button to begin recording.
  - When recording on both sides, press the ▶ button. If the ◀ button is pressed, recording will stop after only one side is recorded.

### To stop recording temporarily

Press the pause (||) button.

- To resume recording, either press the pause (||) button again, or press the playback (▶ or ◀) button.

### To Stop Recording

Press the stop (■) button.

### Erasure prevention tabs

The recording (●) button does not work when the erasure prevention tabs of the loaded cassette tape have been broken off (See page 6). Do not press the recording (●) button with unreasonable force. When recording on both sides, make sure that both tabs are intact.

### ADJUSTING THE RECORDING LEVEL

The adjustment of the recording level is the most important factor in achieving good recording results. A high level provides a good signal-to-noise ratio and dynamic range, but an excessively high level distorts the sound. If the level is set too low for fear of sound distortion, irritating tape hiss will mar the recording. The characteristics of tapes differ depending on the manufacturer and the type of tape. Set the REC LEVEL control so that the level meter's "-3 dB" indicator lights steadily most of the time. No harm will be done if the "0 dB" indicator lights momentarily at peaks. When recording without Dolby NR, set the REC LEVEL control so that the "-3 dB" indicator lights, and the "0 dB" indicator lights occasionally at peaks.

### NOTES:

- The optimal recording level may differ somewhat depending on the audio source and type of tape used. In order to obtain the best possible results, set the recording level after actual testing. Listen to your recordings, and adjust the level as necessary.
- The level meter may react differently during recording and playback of the same tape. This is due to differences in tape sensitivity, and creates no problem.

## RECORDING MUTE

Use this function to create the 4.5-second blanks needed for proper operation of the music search function.

- Press the recording mute (○) button during recording and the deck will create a blank space by recording a section which contains no signal for approximately 4,5 seconds. The deck will then enter recording standby mode.
- To create a blank which is more than 4,5 seconds long, hold the button down for the desired length of time. When the button is released, the deck will enter recording standby mode.
- To resume recording, press the pause (||) button or the playback (▶ or ◀) button.

## ERASING A TAPE

To erase the recorded contents of a tape, load the tape in DECK II and follow the procedure below.

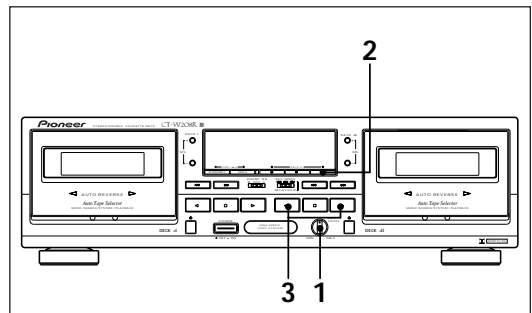

1. Set the REC LEVEL control to the MIN position.
2. Press the recording (●) button.
3. Press the playback (▶ or ◀) button or the pause (||) button.

# TAPE COPYING (from DECK I to DECK II)

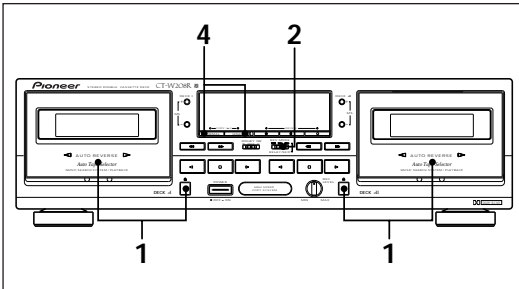

- The tape copying function permits you to copy the contents of a tape from DECK I to Deck II.
  - The SYNCHRO COPY button is used to select either normal speed copying, or high-speed copying (copying at twice the normal playback speed).
1. Load a tape for playback into DECK I and a tape for recording into Deck II.
  2. Set the REV MODE switch.
  3. Set the tape transport direction.
    - Tape copying is always performed in the direction indicated by the tape transport indicator (◁ or ▷). To change this direction, press the desired playback button (▶ or ◀), then immediately press the stop (■) button.
  4. Press the SYNCHRO COPY button to select either NORMAL or HIGH speed.

NORMAL : Tape copying at normal speed allows listen during playback (COPY indicator lights steadily).

HIGH : Tape copying at double speed (COPY indicator flashes). Playback will still audible.

## To stop copying

Press the stop (■) button of either deck. Both decks will stop.

## NOTES:

- The tape in DECK II will be copied in the same type of DOLBY NR (B/C) as DECK I's tape, regardless of its own setting. When listening to the copied tape, set the DOLBY NR (B/C) to the type used for recording.
- If a nearby television set is on while high-speed copying is being performed, a high-pitched interference sound may be heard on the tape. In this case, either use the normal speed copying function, or turn off the television.
- During high-speed copying, none of the operation buttons will function except for the stop (■) button.
- During normal speed copying, the recording mute (⊙) and pause (||) buttons of deck II also function.
- Tape copying is cancelled when either of the two tapes reaches the end. Therefore it is advisable to use tapes of the same length.
- The sound quality of the copied tape will be somewhat less than the original. Therefore when making more than one copy, always record from the original tape (do not make a copy of a copy).
- The recording level adjustment is not necessary during tape copying.

# TROUBLESHOOTING

Incorrect operations are often mistaken for trouble and malfunctions. If you think that there is something wrong with this component, check the points below. Sometimes the trouble may lie in another component. Investigate the other components and electrical appliances being used. If the trouble cannot be rectified even after exercising the checks listed below, ask your nearest PIONEER authorized service center or your dealer to carry out repair work.

Symptom	Cause	Remedy
<b>POWER</b>		
Cannot turn power on.	<ul style="list-style-type: none"> <li>● The power plug is disconnected.</li> <li>● The component (stereo amplifier, audio timer, etc.) to which the power cord is connected is off.</li> </ul>	<ul style="list-style-type: none"> <li>● Connect the power plug.</li> <li>● Turn the stereo amplifier or audio timer on.</li> </ul>
<b>CASSETTE DOOR</b>		
The door does not open.	<ul style="list-style-type: none"> <li>● The deck is not in stop mode (tape is moving).</li> <li>● Power was turned off with the tape moving.</li> </ul>	<ul style="list-style-type: none"> <li>● Press the stop (■) button.</li> <li>● Turn power on.</li> </ul>
The door does not close.	<ul style="list-style-type: none"> <li>● The cassette is not properly loaded.</li> </ul>	<ul style="list-style-type: none"> <li>● Reinsert the cassette.</li> </ul>
<b>PLAYBACK</b>		
Immediately stops.	<ul style="list-style-type: none"> <li>● The tape is completely wound.</li> <li>● The tape is slack.</li> </ul>	<ul style="list-style-type: none"> <li>● Play back in the opposite direction.</li> <li>● Rewind the tape.</li> <li>● Take up the slack (see page 6).</li> </ul>
The level meter does not work.	<ul style="list-style-type: none"> <li>● The tape is blank.</li> <li>● <b>The tape head is dirty.</b></li> </ul>	<ul style="list-style-type: none"> <li>● Replace the blank tape with a recorded one.</li> <li>● <b>Clean the heads (see page 5).</b></li> </ul>
No sound.	<ul style="list-style-type: none"> <li>● The amplifier input selector is not correctly set.</li> <li>● The amplifier volume level setting is too low.</li> <li>● Connection problems (wrong connection, cord removed, poor contact, broken wire.)</li> </ul>	<ul style="list-style-type: none"> <li>● Set the amplifier input selector correctly.</li> <li>● Turn the amplifier volume control up.</li> <li>● Connect securely (see page 7).</li> </ul>
<b>RECORDING</b>		
The recording indicator does not light up.	<ul style="list-style-type: none"> <li>● The cassette erasure prevention tabs are broken.</li> </ul>	<ul style="list-style-type: none"> <li>● Replace the cassette with one whose tabs are intact.</li> <li>● Cover the hole over the tab (see page 6).</li> </ul>
The level meter does not work.	<ul style="list-style-type: none"> <li>● REC LEVEL control is set too low.</li> <li>● The amplifier is not delivering a recording signal (from the tuner, CD player, etc.).</li> <li>● Wrong connection, connection cord removed, poor contact, broken wire.</li> </ul>	<ul style="list-style-type: none"> <li>● Turn REC LEVEL control up (see page 14).</li> <li>● Set the amplifier recording output selector correctly.</li> <li>● Check connections (see page 7).</li> </ul>
Immediately stops.	<ul style="list-style-type: none"> <li>● The tape is completely wound.</li> <li>● The tape is slack.</li> </ul>	<ul style="list-style-type: none"> <li>● Record in the opposite direction.</li> <li>● Rewind the tape.</li> <li>● Take up the slack (see page 6).</li> </ul>
Cannot record.	<ul style="list-style-type: none"> <li>● <b>The head is dirty.</b></li> </ul>	<ul style="list-style-type: none"> <li>● <b>Clean the head (see page 5).</b></li> </ul>
No sound.	<ul style="list-style-type: none"> <li>● Connection problems (wrong connection, cord removed, poor contact, broken wire.)</li> </ul>	<ul style="list-style-type: none"> <li>● Check that the recording and playback connection cords are connected correctly (see page 7).</li> <li>● Set the amplifier selector correctly.</li> </ul>
REC LEVEL control does not function.	<ul style="list-style-type: none"> <li>● The tape is being copied.</li> </ul>	<ul style="list-style-type: none"> <li>● When recording is finished, REC LEVEL control will function.</li> </ul>



## TROUBLESHOOTING

Symptom	Cause	Remedy
<b>POOR SOUND QUALITY</b>		
Unstable or interrupted sound.	<ul style="list-style-type: none"> <li>● <b>The head, pinch rollers and capstans are dirty.</b></li> <li>● The tape is not uniformly wound.</li> </ul>	<ul style="list-style-type: none"> <li>● <b>Clean the head (see page 5).</b></li> <li>● Completely fast-forward or rewind the tape.</li> </ul>
No high frequencies.	<ul style="list-style-type: none"> <li>● A tape recorded without Dolby NR is being played back with the DOLBY NR switch in the B or C position.</li> <li>● <b>The head is dirty.</b></li> </ul>	<ul style="list-style-type: none"> <li>● Set the DOLBY NR switch to OFF.</li> <li>● <b>Clean the head (see page 5).</b></li> </ul>
High frequencies are emphasized.	<ul style="list-style-type: none"> <li>● A Dolby NR-encoded tape is being played back with the DOLBY NR switch in the OFF position.</li> </ul>	<ul style="list-style-type: none"> <li>● Set DOLBY NR (B/C) switch to the same position used for recording.</li> </ul>
Sound from previous recordings remains when rerecording a tape.	<ul style="list-style-type: none"> <li>● <b>The head is dirty.</b></li> </ul>	<ul style="list-style-type: none"> <li>● <b>Clean the head (see page 5).</b></li> </ul>
The sound is distorted.	<ul style="list-style-type: none"> <li>● Recording level is too high.</li> <li>● The recorded signal itself is distorted.</li> <li>● <b>The head is dirty.</b></li> </ul>	<ul style="list-style-type: none"> <li>● Turn REC LEVEL control down when recording(see page 14).</li> <li>● Replace the cassette.</li> <li>● <b>Clean the head (see page 5).</b></li> </ul>
Too much noise.	<ul style="list-style-type: none"> <li>● High noise tape is being used.</li> <li>● Incomplete insertion of a connection cord, poor contact.</li> <li>● Recording level is too low.</li> <li>● <b>The head is dirty.</b></li> <li>● The head is magnetized.</li> </ul>	<ul style="list-style-type: none"> <li>● Replace the cassette.</li> <li>● Check connections (see page 7).</li> <li>● Turn REC LEVEL control up when recording (see page 14).</li> <li>● <b>Clean the head (see page 5).</b></li> <li>● Demagnetize with a head demagnetizer (see page 5).</li> </ul>
<b>OTHERS</b>		
The music search function does not work.	<ul style="list-style-type: none"> <li>● Blanks between selections are less than 4 seconds long.</li> </ul>	<ul style="list-style-type: none"> <li>● Use a tape with blanks more than 4 seconds long.</li> </ul>
Cannot use the remote control system.	<ul style="list-style-type: none"> <li>● The remote control cord is not connected.</li> </ul>	<ul style="list-style-type: none"> <li>● Connect the remote control cord (see page 7).</li> </ul>

*Abnormal functioning of this unit may be caused by static electricity, or other external interference. To restore normal operation, turn the power off and then on again, or unplug the AC power cord and then plug it in again.*





