

**YAMAHA**

OWNER'S MANUAL

***VIRAGO***

***XV535L, XV535LC***

LIT-11626-12-28

3JC-28199-17

Congratulations on your purchase of the Yamaha XV535/XV535C. This model is the result of Yamaha's vast experience in the production of fine sporting, touring, and pacemaking racing machines. It represents the high degree of craftsmanship and reliability that have made Yamaha a leader in these fields.

This manual will give you an understanding of the operation, inspection, and basic maintenance of this motorcycle. If you have any questions about the operation or maintenance of your motorcycle, please consult a Yamaha dealer.

The design and manufacture of this Yamaha motorcycle fully comply with the emissions standards for clean air applicable at the date of manufacture. Yamaha has met these standards without reducing the motorcycle's performance or economy of operation. To maintain these high standards, it is important that you and your dealer pay close attention to the recommended maintenance schedules and operating instructions contained within this manual.

# IMPORTANT MANUAL INFORMATION

---

EAU00003

Particularly important information is distinguished in this manual by the following notations:



The Safety Alert Symbol means **ATTENTION! BECOME ALERT! YOUR SAFETY IS INVOLVED!**



Failure to follow **WARNING** instructions could result in severe injury or death to the motorcycle operator, a bystander or a person inspecting or repairing the motorcycle.



A **CAUTION** indicates special precautions that must be taken to avoid damage to the motorcycle.



A **NOTE** provides key information to make procedures easier or clearer.

## **NOTE:**

- This manual should be considered a permanent part of this motorcycle and should remain with it even if the motorcycle is subsequently sold.
  - Yamaha continually seeks advancements in product design and quality. Therefore, while this manual contains the most current product information available at the time of printing, there may be minor discrepancies between your motorcycle and this manual. If there is any question concerning this manual, please consult your Yamaha dealer.
-

# IMPORTANT MANUAL INFORMATION

---

---

EW000000

## **WARNING**

**PLEASE READ THIS MANUAL AND THE “YOU AND YOUR MOTORCYCLE: RIDING TIPS” BOOKLET CAREFULLY AND COMPLETELY BEFORE OPERATING THIS MOTORCYCLE. DO NOT ATTEMPT TO OPERATE THIS MOTORCYCLE UNTIL YOU HAVE ATTAINED A SATISFACTORY KNOWLEDGE OF ITS CONTROLS AND OPERATING FEATURES AND UNTIL YOU HAVE BEEN TRAINED IN SAFE AND PROPER RIDING TECHNIQUES. REGULAR INSPECTIONS AND CAREFUL MAINTENANCE, ALONG WITH GOOD RIDING SKILLS, WILL ENSURE THAT YOU SAFELY ENJOY THE CAPABILITIES AND THE RELIABILITY OF THIS MOTORCYCLE.**

---

---

---

AFFIX DEALER

LABEL HERE

EAU01399

**XV535L/XV535LC  
OWNER'S MANUAL**

**© 1998 by Yamaha Motor Corporation, U.S.A.  
1st Edition, July 1998**

**All rights reserved. Any reprinting or  
unauthorized use without the written  
permission of Yamaha Motor Corporation,  
U.S.A. is expressly prohibited.**

**Printed in Japan  
P/N LIT-11626-12-28**

# TABLE OF CONTENTS

1 SAFETY INFORMATION

1

2 DESCRIPTION

2

3 INSTRUMENT AND CONTROL FUNCTIONS

3

4 PRE-OPERATION CHECKS

4

5 OPERATION AND IMPORTANT RIDING POINTS

5

6 PERIODIC MAINTENANCE AND MINOR REPAIR

6

7 CLEANING AND STORAGE

7

8 SPECIFICATIONS

8

9 CONSUMER INFORMATION

9

INDEX



Safety information .....	1-1
Safe riding .....	1-1
Protective apparel .....	1-2
Modification .....	1-3
Loading and accessories .....	1-3
Gasoline and exhaust gas.....	1-5
Location of the important labels .....	1-7



TWO-WHEELED MOTORCYCLES ARE SINGLE TRACK VEHICLES. THEIR SAFE USE AND OPERATION ARE DEPENDENT UPON THE USE OF PROPER RIDING TECHNIQUES AS WELL AS THE EXPERTISE OF THE OPERATOR. EVERY OPERATOR SHOULD KNOW THE FOLLOWING REQUIREMENTS BEFORE RIDING.

HE OR SHE SHOULD:

1. OBTAIN THOROUGH INSTRUCTIONS FROM A COMPETENT SOURCE ON ALL ASPECTS OF MOTORCYCLE OPERATION.
2. OBSERVE THE WARNINGS AND MAINTENANCE REQUIREMENTS IN THE OWNER'S MANUAL.
3. OBTAIN QUALIFIED TRAINING IN SAFE AND PROPER RIDING TECHNIQUES.
4. OBTAIN PROFESSIONAL TECHNICAL SERVICE AS INDICATED BY THE OWNER'S MANUAL AND/OR WHEN MADE NECESSARY BY MECHANICAL CONDITIONS.

## Safe riding

1. Always make pre-operation checks. Careful checks may help prevent an accident.
2. This motorcycle is designed to carry the operator and a passenger.
3. The failure of motorists to detect and recognize motorcycles in traffic is the predominating cause of automobile/motorcycle accidents. Many accidents have been caused by an automobile driver who did not see the motorcycle. Making yourself conspicuous appears to be very effective in reducing the chance of this type of accident.

Therefore:

- a. Wear a brightly colored jacket.
- b. Use extra caution when you approach and pass through intersections, since intersections are the most likely places for motorcycle accidents.
- c. Ride where other motorists can see you. Avoid riding in another motorist's "blind spot".





4. Many accidents involve inexperienced operators. In fact, many operators who have been involved in accidents do not even have a current motorcycle license.
  - a. Make sure you are qualified. Also, only lend your motorcycle to experienced operators.
  - b. Know your skills and limits. Staying within your limits may help you to avoid an accident.
  - c. We recommend that you practice riding your motorcycle where there is no traffic until you have become thoroughly familiar with your motorcycle and all of its controls.
5. Many motorcycle accidents have been caused by motorcycle operator errors. A typical error made by the operator is veering wide on a turn due to EXCESSIVE SPEED or undercornering (insufficient lean angle for the speed).
  - a. Always obey the speed limits and never travel faster than warranted by road and traffic conditions.
  - b. Always signal before turning or changing lanes. Make sure other motorists see you.
6. The operator's and passenger's posture are important for proper control.
  - a. The operator should keep both hands on the handlebars and both feet on the operator footrests during operation to maintain control of the motorcycle.
  - b. The passenger should always hold on to the operator, or the seat strap or grab bar if the motorcycle is so equipped, with both hands and keep both feet on the passenger footrests.
  - c. Never carry a passenger unless he or she can firmly place both feet on the passenger footrests.
7. Never ride under the influence of alcohol or drugs.
8. This motorcycle is designed for on-road use only. It is not suitable for off-road use.

### **Protective apparel**

The majority of fatalities from motorcycle accidents are the result of head injuries. The use of a safety helmet is the single most critical factor in the prevention or reduction of head injuries.

1. Always wear an approved helmet.



## SAFETY INFORMATION

---

2. Wear a face shield or goggles. Wind on your unprotected eyes could contribute to an impairment of vision which could delay seeing a hazard.
3. The use of heavy boots, jacket, trousers, gloves, etc. is effective in preventing or reducing abrasions or lacerations.
4. Never wear loose fitting clothing. It could catch on the control levers, footrests, or wheels and cause injury or accident.
5. Never touch the engine or exhaust system during or after operation. They become very hot and can cause burns. Always wear protective clothing that covers your legs, ankles, and feet.
6. A passenger should also observe the above precautions.

### **Modification**

Modifications made to the motorcycle not approved by Yamaha, or the removal of original equipment, may render your motorcycle unsafe for use and may cause severe personal injury. Modifications may also make your motorcycle illegal to use.

### **Loading and accessories**

Adding accessories or cargo to your motorcycle can adversely affect stability and handling if the weight distribution of the machine is changed. To avoid the possibility of an accident, extreme caution should be used if adding cargo or accessories to your motorcycle. Use extra care if riding a motorcycle which has added cargo or accessories. Here are some general guidelines to follow if loading cargo or adding accessories to your motorcycle:

#### **Loading**

The total weight of the operator, passenger, accessories and cargo must not exceed the maximum load limit of XV535 : 485 lb (220 kg) / XV535C : 483 lb (219 kg)



When loading within these weight limits, keep the following in mind:

1. Cargo and accessory weight should be kept as low and close to the motorcycle as possible. Be sure to distribute the weight as evenly as possible on both sides of the machine to minimize imbalance or instability.
2. Shifting weights can create a sudden imbalance. Make sure that accessories and cargo are securely attached to the motorcycle before riding. Recheck accessory mounts and cargo restraints frequently.
3. Never attach any large or heavy items to the handlebars, front forks, or front fender. These items, including such cargo as sleeping bags, duffle bags, or tents, can create unstable handling or slow steering response.

## **Accessories**

Genuine Yamaha accessories have been specifically designed for use on this motorcycle. Since Yamaha cannot test all other accessories which may be available, you must personally be responsible for the proper selection, installation and use of non-Yamaha accessories. You should use extreme caution when selecting and installing any accessories.

Keep in mind these guidelines for mounting accessories in addition to those provided under “LOADING”.

1. Never install accessories or carry cargo that would impair the performance of your motorcycle. Carefully inspect the accessory before using it to make sure it does not in any way reduce ground clearance or cornering clearance, limit suspension travel, steering travel or control operation, or obscure lights or reflectors.
  - a. Accessories fitted to the handlebar or the front fork area can create instability due to improper weight distribution or aerodynamic changes. If accessories are added to the handlebar or front fork area, they must be as lightweight as possible and should be kept to a minimum.



## **SAFETY INFORMATION**

---

- b. Bulky or large accessories may seriously affect the stability of the motorcycle due to aerodynamic effects. Wind may attempt to lift the motorcycle, or the motorcycle may become unstable in cross winds. These accessories may also cause instability when being passed by or passing large vehicle.
  - c. Certain accessories can displace the operator from his or her normal riding position. This improper position limits the freedom of movement of the operator and may limit control ability. Therefore such accessories are not recommended.
2. Caution must be used if adding electrical accessories. If these accessories exceed the capacity of the motorcycle's electrical system, an electric failure could result, which could cause a dangerous loss of lights or engine power.

### **Gasoline and exhaust gas**

1. **GASOLINE IS HIGHLY FLAMMABLE:**
  - a. Always turn off the engine when refueling.
  - b. Take care not to spill any gasoline on the engine or exhaust system when refueling.
  - c. Never refuel while smoking or in the vicinity of an open flame.
2. Never start the engine or let it run for any length of time in a closed area. The exhaust fumes are poisonous and may cause loss of consciousness and death within a short time. Always operate your motorcycle in an area that has adequate ventilation.
3. Always turn off the engine before leaving the motorcycle unattended and remove the ignition key. When parking the motorcycle, note the following:
  - a. The engine and exhaust system may be hot. Park the motorcycle in a place where pedestrians or children are not likely to touch these hot areas.
  - b. Do not park the motorcycle on a slope or soft ground; the motorcycle may fall over.
  - c. Do not park the motorcycle near a flammable source, e.g. a kerosene heater, or near an open flame. The motorcycle could catch fire.



## SAFETY INFORMATION

---

4. When transporting the motorcycle in another vehicle, be sure it is kept upright and that the fuel cock is turned to “ON” or “RES” (for vacuum type) / “OFF” (for manual type). If it should lean over, gasoline may leak out of the carburetor or fuel tank.
5. If you should swallow any gasoline, inhale a lot of gasoline vapor, or allow gasoline to get in your eyes, see your doctor immediately. If any gasoline spills on your skin or clothing, immediately wash it off with soap and water and change your clothes.



# SAFETY INFORMATION

EAU00025

## Location of the important labels

Please read the following labels carefully before operating this motorcycle.

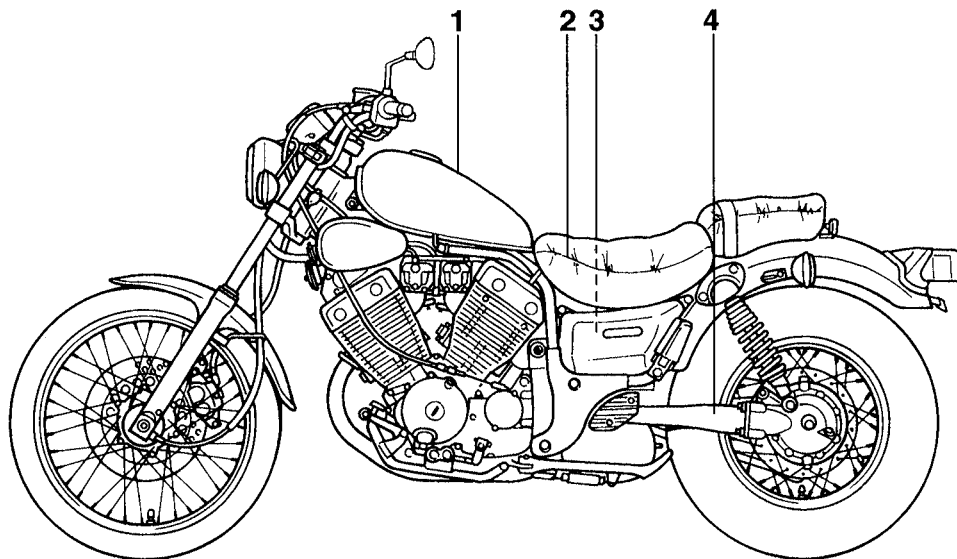



# SAFETY INFORMATION

1

**⚠ WARNING**

- **BEFORE YOU OPERATE THIS VEHICLE, READ THE OWNER'S MANUAL AND ALL LABELS.**
- **ALWAYS WEAR AN APPROVED MOTORCYCLE HELMET,** eye protection, and protective clothing.

3MX-2118K-A0

3 California only

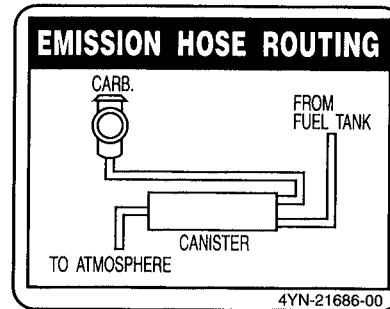

1

2

**CAUTION**

- Read owner's manual before servicing battery.
- Electrolyte will damage metal parts or paint. If electrolyte spills, wash area with fresh water immediately.
- Be sure to connect breather hose after installing battery.

3JL-28177-A0

4

**TIRE INFORMATION**

Cold tire normal pressure should be set as follows.

- Up to 90 kg (198 lbs) load

<b>FRONT</b>	: 200kPa, {2.00kgf/cm <sup>2</sup> }, 29psi
<b>REAR</b>	: 225kPa, {2.25kgf/cm <sup>2</sup> }, 33psi

- 90 kg (198 lbs) ~ maximum load

<b>FRONT</b>	: 200kPa, {2.00kgf/cm <sup>2</sup> }, 29psi
<b>REAR</b>	: 250kPa, {2.50kgf/cm <sup>2</sup> }, 36psi

SFB-21686-00

Left view .....	2-1
Right view.....	2-2
Controls/Instruments .....	2-3



# DESCRIPTION

## Left view

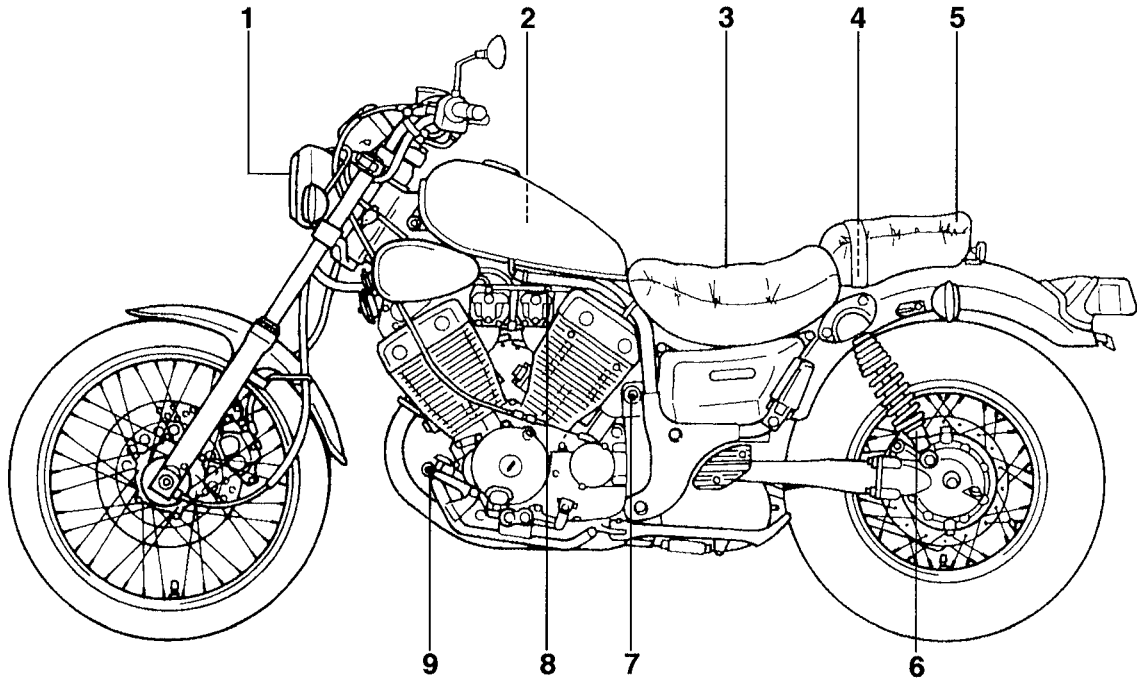

- |                   |             |   |            |
|-------------------|-------------|---|------------|
| 1. Headlight      | (page 6-29) | 6. Rear shock absorber spring<br>preload adjusting ring | (page 3-9) |
| 2. Air filter     | (page 6-13) | 7. Main switch  | (page 3-1) |
| 3. Rider seat     | (page 3-8)  | 8. Starter (choke) “  \”                                | (page 3-6) |
| 4. Tool kit       | (page 6-1)  | 9. Shift pedal  | (page 3-4) |
| 5. Passenger seat | (page 3-7)  |   |            |

## Right view

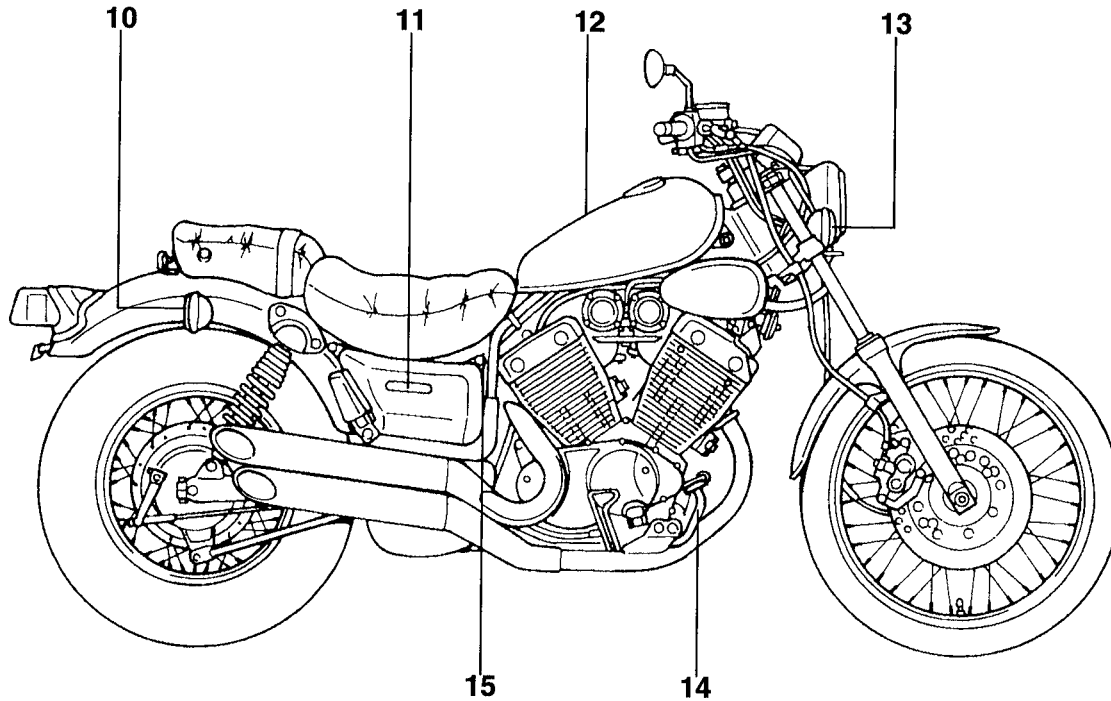

- 10. Rear flasher light (page 6-31)
- 11. Fuel tank
- 12. Sub fuel tank (page 3-5)

- 13. Front flasher / position light
- 14. Rear brake pedal (page 3-4)
- 15. Battery (page 6-27)

# DESCRIPTION

---

## Controls/Instruments

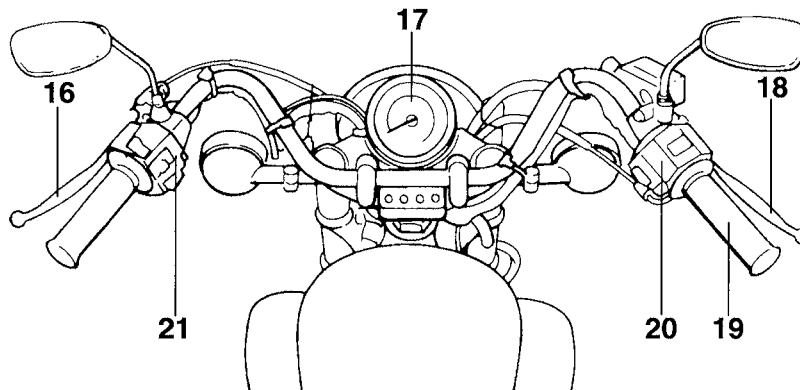

- |                              |             |
|------------------------------|-------------|
| 16. Clutch lever             | (page 3-3)  |
| 17. Speedometer              | (page 3-2)  |
| 18. Front brake lever        | (page 3-4)  |
| 19. Throttle grip            | (page 6-15) |
| 20. Right handlebar switches | (page 3-3)  |
| 21. Left handlebar switches  | (page 3-2)  |

# INSTRUMENT AND CONTROL FUNCTIONS

Main switch .....	3-1
Indicator lights .....	3-1
Speedometer.....	3-2
Handlebar switches.....	3-2
Clutch lever .....	3-3
Shift pedal .....	3-4
Front brake lever .....	3-4
Rear brake pedal.....	3-4
Fuel tank cap.....	3-5
Fuel .....	3-5
Starter (choke) “ ↘ ” .....	3-6
Steering lock .....	3-7
Seat.....	3-7
Helmet holder.....	3-8
Rear shock absorber adjustment .....	3-9
Sidestand .....	3-9
Sidestand/clutch switch operation check .....	3-10

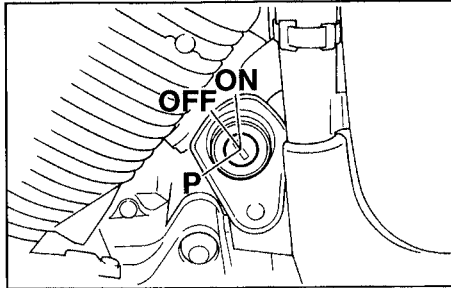

EAU00028

## Main switch

The main switch controls the ignition and lighting systems. Its operation is described below.

EAU00032

### ON

All electrical circuits are switched on, and the headlight, meter light, taillight, and front position lights come on. The engine can be started. The key cannot be removed in this position.

EAU00038

### OFF

All electrical circuits are switched off. The key can be removed in this position.

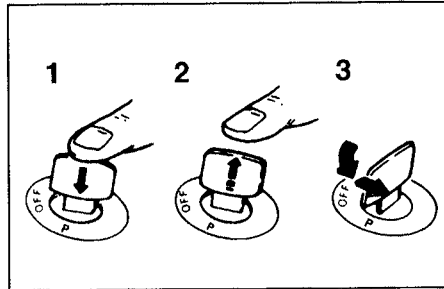

1. Push
2. Release
3. Turn

EAU00052

### P (Parking)

The taillight and front position light come on but all other circuits are off. With the key at "OFF", push it into the main switch and release it. Then turn it counterclockwise to "P", and remove it. To cancel the parking, turn the key clockwise.

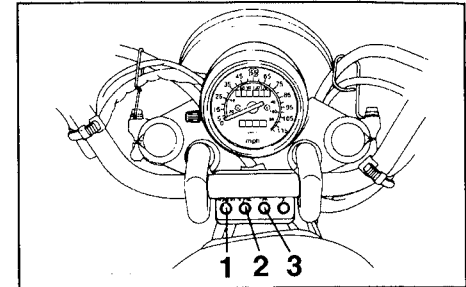

1. High beam indicator light "HIGH BEAM"
2. Neutral indicator light "NEUTRAL"
3. Turn indicator light "TURN"

EAU00056

## Indicator lights

EAU00064

### High beam indicator light "HIGH BEAM"

This indicator comes on when the headlight high beam is used.

EAU00062

### Neutral indicator light "NEUTRAL"

This indicator comes on when the transmission is in neutral.

EAU00059

### Turn indicator light "TURN"

This indicator flashes when the turn switch is moved to the left or right.

# INSTRUMENT AND CONTROL FUNCTIONS

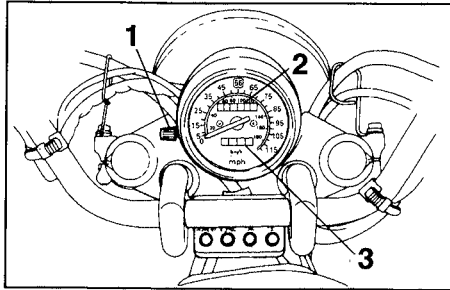

1. Reset knob
2. Odometer
3. Trip odometer

EAU00095

## Speedometer

The speedometer shows riding speed. This speedometer is equipped with an odometer and trip odometer. The trip odometer can be reset to "0" with the reset knob. Use the trip odometer to estimate how far you can ride on a tank of fuel. This information will enable you to plan fuel stops in the future.

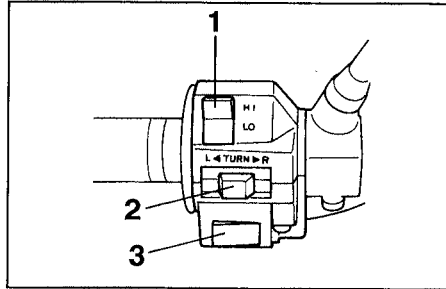

1. Dimmer switch "LIGHTS"
2. Turn signal switch "TURN"
3. Horn switch "HORN"

EAU00118

## Handlebar switches

EAU00122

### Dimmer switch "LIGHTS"

Turn the switch to "HI" for the high beam and to "LO" for the low beam.

EAU01189

### Turn signal switch "TURN"

This model is equipped with self-canceling turn signals. To signal a right-hand turn, push the switch to the right. To signal a left-hand turn, push the switch to the left. Once the switch is released, it will return to the center position and self-cancel after the motorcycle has traveled both about 150 m (490 ft) and for approximately 15 seconds. The self-canceling mechanism only operates when the motorcycle is moving. Therefore the signal will not self-cancel while you are stopped at an intersection. The signal may also be canceled manually by pushing the switch in after it has returned to the center position.

3

EAU00130

### Horn switch "HORN"

Press the switch to sound the horn.

# INSTRUMENT AND CONTROL FUNCTIONS

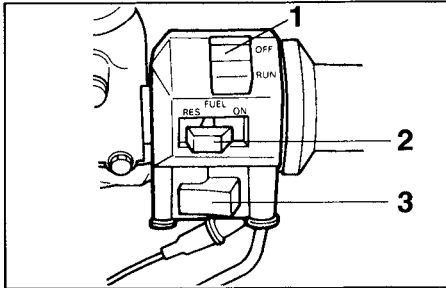

1. Engine stop switch "ENGINE STOP"
2. Fuel reserve switch "FUEL"
3. Start switch "START"

EAU00137

## Engine stop switch "ENGINE STOP"

The engine stop switch is a safety device for use in an emergency such as when the motorcycle overturns or if trouble occurs in the throttle system. Turn the switch to "RUN" to start the engine. In case of emergency, turn the switch to "OFF" to stop the engine.

EAU00149

## Fuel reserve switch "FUEL"

This switch should usually be kept "ON" while riding. If you run out of fuel while riding, move the switch to "RES" and refuel at the first opportunity. Then move the switch to "ON".

### NOTE:

When the switch is turned to reserve "RES", about 2.5 L (0.5 Imp gal, 0.7 US gal) remain in the fuel tank.

EAU00141

## Start switch "START"

The starter motor cranks the engine when pushing the start switch.

EC000005

### CAUTION:

**See starting instructions prior to starting the engine.**

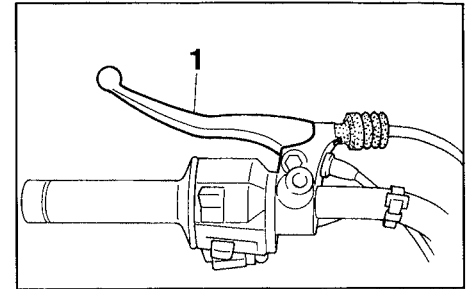

1. Clutch lever

EAU00152

## Clutch lever

The clutch lever is located on the left handlebar, and the ignition circuit cut-off system is incorporated in the clutch lever holder. Pull the clutch lever to the handlebar to disengage the clutch, and release the lever to engage the clutch. The lever should be pulled rapidly and released slowly for smooth clutch operation. (Refer to the engine starting procedures for a description of the ignition circuit cut-off system.)

# INSTRUMENT AND CONTROL FUNCTIONS

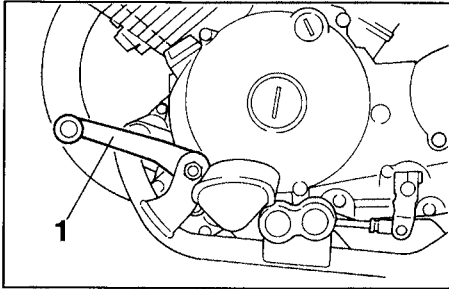

1. Shift pedal

EAU00157

## Shift pedal

This motorcycle is equipped with a constant-mesh 5-speed transmission. The shift pedal is located on the left side of the engine and is used in combination with the clutch when shifting.

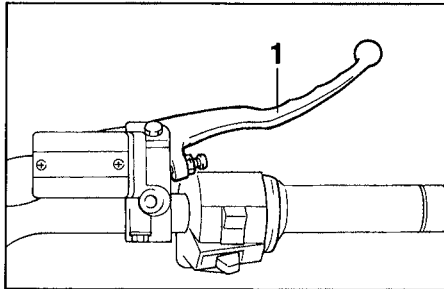

1. Front brake lever

EAU00158

## Front brake lever

The front brake lever is located on the right handlebar. Pull it toward the handlebar to apply the front brake.

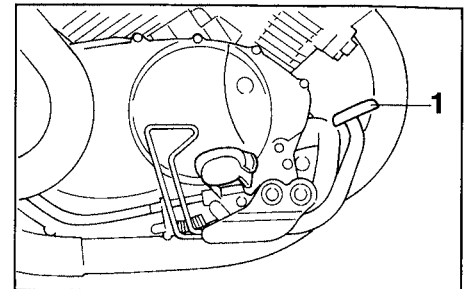

1. Rear brake pedal

EAU00162

## Rear brake pedal

The rear brake pedal is on the right side of the motorcycle. Press down on the brake pedal to apply the rear brake.



# INSTRUMENT AND CONTROL FUNCTIONS

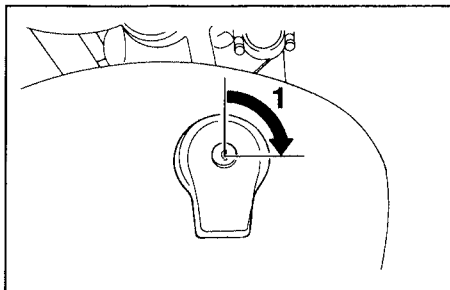

1. Open

EAU00167

## Fuel tank cap

### To open

Insert the key and turn it 1/4 turn clockwise. The lock will be released and the cap can be opened.

### To close

Push the tank cap into position with the key inserted. To remove the key, turn it counterclockwise to the original position.

### NOTE:

This tank cap cannot be closed unless the key is in the lock. The key cannot be removed if the cap is not locked properly.

EW000023

### WARNING

**Be sure the cap is properly installed and locked in place before riding the motorcycle.**

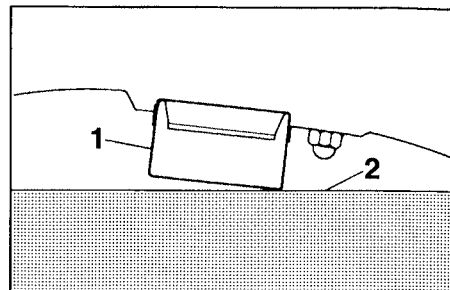

1. Filler tube
2. Fuel level

EAU01183

## Fuel

Make sure there is sufficient fuel in the tank. Fill the fuel tank to the bottom of the filler tube as shown in the illustration.

EW000130

### WARNING

**Do not overfill the fuel tank. Avoid spilling fuel on the hot engine. Do not fill the fuel tank above the bottom of the filler tube or it may overflow when the fuel heats up later and expands.**

# INSTRUMENT AND CONTROL FUNCTIONS

## CAUTION:

Always wipe off spilled fuel immediately with a dry and clean soft cloth. Fuel may deteriorate painted surfaces or plastic parts.

EAU00185

Your Yamaha engine has been designed to use regular unleaded gasoline with a pump octane number  $([R+M]/2)$  of 86 or higher, or research octane number of 91 or higher. If knocking or pinging occurs, use a different brand of gasoline or premium unleaded fuel. Unleaded fuel will give you longer spark plug life and reduced maintenance cost. If unleaded gasoline is not available, then leaded regular gasoline can be used.

## Gasohol

There are two types of gasohol; gasohol containing ethanol and that containing methanol. Gasohol containing ethanol can be used if ethanol content does not exceed 10%. Gasohol containing methanol is not recommended by Yamaha because it can cause fuel system damage or vehicle performance problems.

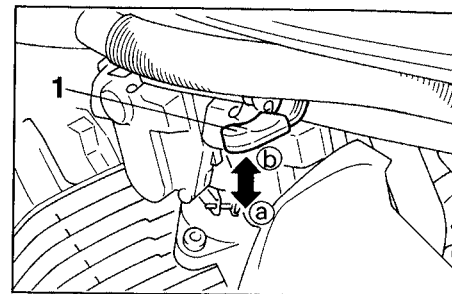

1. Starter (choke) “|∨|”

## Starter (choke) “|∨|”

EAU00210

Starting a cold engine requires a richer air-fuel mixture. A separate starter circuit supplies this mixture.

Move in direction ① to turn on the starter (choke).

Move in direction ② to turn off the starter (choke).

EAU00189

Recommended fuel:

UNLEADED FUEL

Fuel tank capacity:

Total:

13.5 L (3.0 Imp gal, 3.6 US gal)

Reserve:

2.5 L (0.5 Imp gal, 0.7 US gal)

# INSTRUMENT AND CONTROL FUNCTIONS

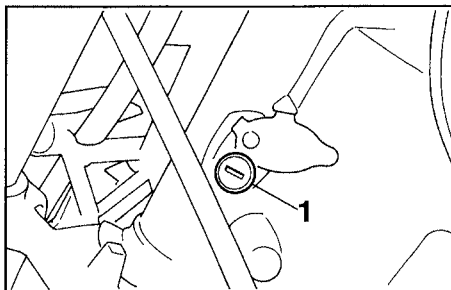

1. Steering lock

EAU01499

## Steering lock

### To lock the steering

Turn the handlebars all the way to the right and open the steering lock cover. Insert the key and turn it 1/8 turn counterclockwise. Then, push the key in while turning the handlebars slightly to the left and turn the key 1/8 turn clockwise.

Check that the steering is locked, remove the key and close the lock cover.

### To release the lock

Insert the key, push it in and turn it 1/8 turn counterclockwise so that it moves out. Then, release and remove the key.

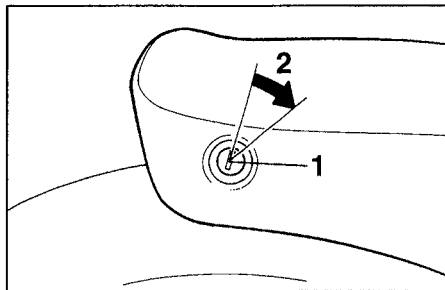

1. Seat lock  
2. Open

EAU00249

## Seat

### Passenger seat

To remove the passenger seat, insert the key in the lock and turn it clockwise.

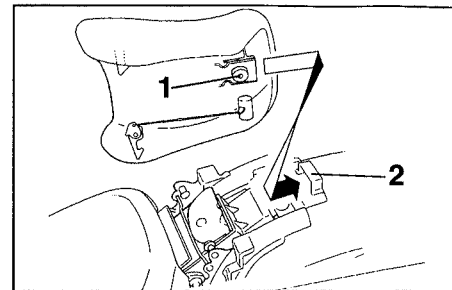

1. Projection  
2. Seat holder

To reinstall the passenger seat, insert the projection on the rear of the seat into the seat holder, then push down the seat.

# INSTRUMENT AND CONTROL FUNCTIONS

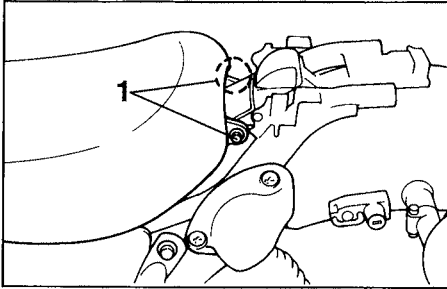

1. Bolt (× 2)

## Rider seat

To remove the rider seat, first remove the passenger seat, then the two rider seat bolts.

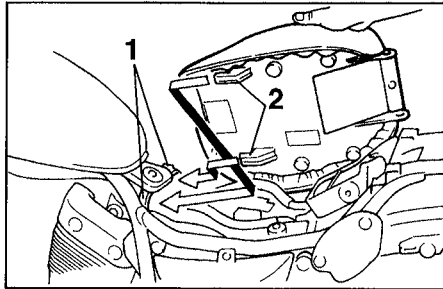

1. Seat holder (× 2)

2. Projection (× 2)

To reinstall the rider seat, insert the projections on the front of the seat into the seat holders and tighten the bolts. Then reinstall the passenger seat.

**NOTE:** \_\_\_\_\_

Make sure that the seat is securely fitted.

\_\_\_\_\_

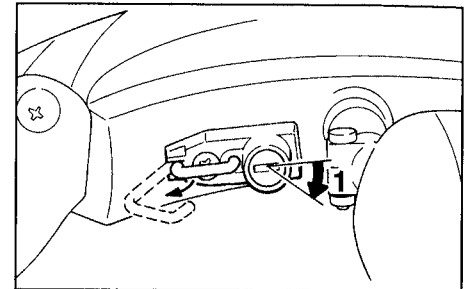

1. Open

## Helmet holder

To open the helmet holder, insert the key in the lock and turn it as shown. To lock the helmet holder, replace the holder in its original position.

EAU00260

EW000030

## **⚠ WARNING**

**Never ride with a helmet in the helmet holder. The helmet may hit objects, causing loss of control and possibly an accident.**

\_\_\_\_\_

# INSTRUMENT AND CONTROL FUNCTIONS

EAU00330

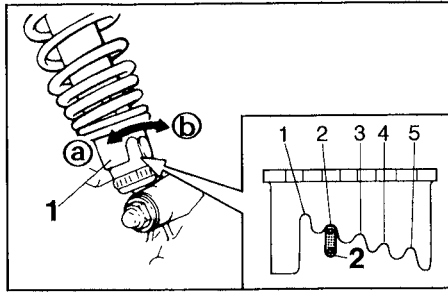

1. Spring preload adjusting ring
2. Position indicator

EAU00300

## Rear shock absorber adjustment

Each shock absorber is equipped with a spring preload adjusting ring. Adjust spring preload as follows. Turn the adjusting ring in direction (a) to increase spring preload and in direction (b) to decrease spring preload. Make sure that the appropriate notch in the adjusting ring is aligned with the position indicator on the rear shock absorber.

	Soft	Standard	Hard		
Adjusting position	1	2	3	4	5

EW000040

### **! WARNING**

**Always adjust each shock absorber to the same setting. Uneven adjustment can cause poor handling and loss of stability.**

## Sidestand

This model is equipped with an ignition circuit cut-off system. The motorcycle must not be ridden when the sidestand is down. The sidestand is located on the left side of the frame. (Refer to page 5-1 for an explanation of this system.)

EW000044

### **! WARNING**

**This motorcycle must not be operated with the sidestand in the down position. If the stand is not properly retracted, it could contact the ground and distract the operator, resulting in a possible loss of control. Yamaha has designed into this motorcycle a lockout system to assist the operator in fulfilling the responsibility of retracting the sidestand. Please check carefully the operating instructions listed below and if there is any indication of a malfunction, return the motorcycle to a Yamaha dealer immediately for repair.**

EAU00391

## Sidestand/clutch switch operation check

Check the operation of the sidestand switch and clutch switch against the information below.

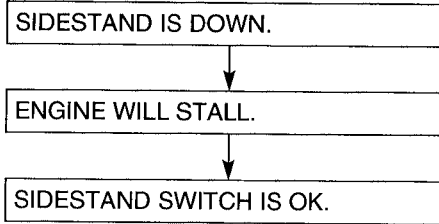
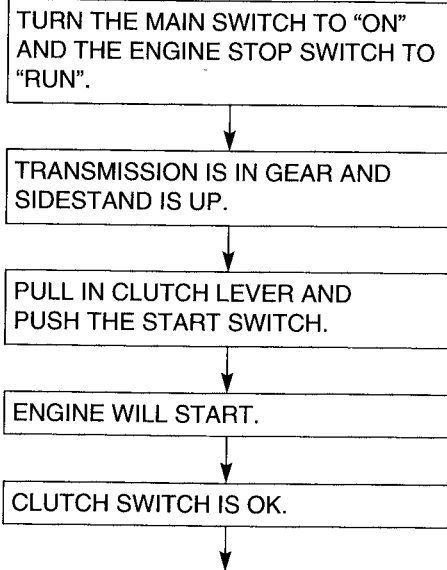

EW000045

### **WARNING**

**If improper operation is noted, consult a Yamaha dealer immediately.**

# PRE-OPERATION CHECKS

Pre-operation check list..... 4-1

# PRE-OPERATION CHECKS

EAU01114

Owners are personally responsible for their vehicle's condition. Your motorcycle's vital functions can start to deteriorate quickly and unexpectedly, even if it remains unused (for instance, if it is exposed to the elements). Any damage, fluid leak or loss of tire pressure could have serious consequences. Therefore, it is very important that, in addition to a thorough visual inspection, you check the following points before each ride.

EAU00340

## PRE-OPERATION CHECK LIST

No.	ITEM	ROUTINE	PAGE
1	Front brake	<ul style="list-style-type: none"><li>• Check operation, free play, fluid level and fluid leakage.</li><li>• Fill with DOT 4 (or DOT 3) brake fluid if necessary.</li></ul>	6-20 ~ 6-24
2	Rear brake	<ul style="list-style-type: none"><li>• Check operation and free play.</li><li>• Adjust if necessary.</li></ul>	
3	Clutch	<ul style="list-style-type: none"><li>• Check operation, condition and clutch lever free play.</li><li>• Adjust if necessary.</li></ul>	6-19
4	Engine oil	<ul style="list-style-type: none"><li>• Check engine oil level, fill engine with oil if necessary.</li></ul>	6-10 ~ 6-12
5	Final gear oil	<ul style="list-style-type: none"><li>• Check for leakage.</li></ul>	6-12 ~ 6-13
6	Throttle	<ul style="list-style-type: none"><li>• Check for smooth operation.</li></ul>	6-15
7	Battery	<ul style="list-style-type: none"><li>• Check fluid level, fill with distilled water if necessary.</li></ul>	6-27 ~ 6-28
8	Lights, signals and switches	<ul style="list-style-type: none"><li>• Check operation.</li></ul>	6-29 ~ 6-31
9	Wheels/Tires	<ul style="list-style-type: none"><li>• Check tire pressure, wear, damage and spoke tightness.</li></ul>	6-16 ~ 6-18
10	Chassis fasteners	<ul style="list-style-type: none"><li>• Check the tightness of all chassis nuts, bolts and screws.</li><li>• Adjust if necessary.</li></ul>	—



# PRE-OPERATION CHECKS

---

---

## NOTE:

Pre-operation checks should be made each time the motorcycle is used. Such an inspection can be thoroughly accomplished in a very short time; and the added safety it assures is more than worth the time involved.

---

## WARNING

- The engine, exhaust pipes, and mufflers will be very hot after the engine has been run. Be careful not to touch them or to allow any clothing item to contact them during inspection or repair.
  - If any item in the PRE-OPERATION CHECK is not working properly, have it inspected and repaired before operating the motorcycle.
-

# OPERATION AND IMPORTANT RIDING POINTS

---

Starting and warming up a cold engine.....	5-1
Starting a warm engine .....	5-4
Shifting .....	5-4
To start out and accelerate .....	5-5
To decelerate .....	5-5
Recommended shift point .....	5-5
Engine break-in .....	5-6
Parking .....	5-7

EAU00373

** WARNING**

- Before riding this motorcycle, become thoroughly familiar with all operating controls and their functions. Consult a Yamaha dealer regarding any control or function that you do not thoroughly understand.
- Never start your engine or let it run for any length of time in a closed area. The exhaust fumes are poisonous and can cause loss of consciousness and death within a short time. Always operate your motorcycle in an area with adequate ventilation.
- Before starting out, always be sure the sidestand is up. Failure to retract the sidestand completely can result in a serious accident when you try to turn a corner.

**CAUTION:**

- Be careful where you store personal items on the motorcycle. Avoid blocking the air cleaner intake or performance will suffer.
- Be careful not to put anything near the battery and its terminals. Electrical failure and acid corrosion may result.

EAU00376

## Starting and warming up a cold engine

**NOTE:**

This motorcycle is equipped with an ignition circuit cut-off system.

The engine can be started only under the following conditions:

- The transmission is in neutral.
- The sidestand is up, the transmission is in gear and the clutch is disengaged.

The motorcycle must not be ridden when the sidestand is down.

EW000054

** WARNING**

Before going through the following steps, check the function of the sidestand switch and clutch switch. (Refer to page 3-10.)

# OPERATION AND IMPORTANT RIDING POINTS

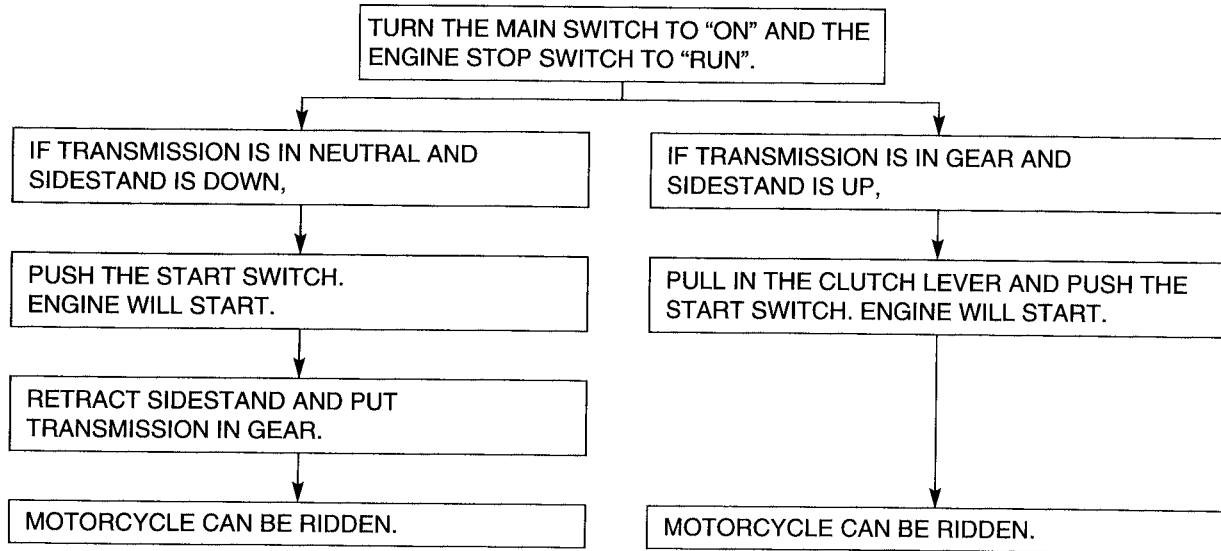

# OPERATION AND IMPORTANT RIDING POINTS

---

1. Turn the main switch to “ON” and the engine stop switch to “RUN”.
2. Shift the transmission into neutral.

**NOTE:** \_\_\_\_\_

When the transmission is in neutral, the neutral indicator light should be on. If the light does not come on, ask a Yamaha dealer to inspect it.

---

3. Turn on the starter (choke) and completely close the throttle grip.
4. Start the engine by pushing the start switch.

**NOTE:** \_\_\_\_\_

If the engine fails to start, release the start switch, wait a few seconds, then try again. Each attempt should be as short as possible to preserve the battery. Do not crank the engine more than 10 seconds on any one attempt.

---

5. After starting the engine, move the starter (choke) back to the halfway position.

**NOTE:** \_\_\_\_\_

For maximum engine life, always warm up the engine before starting off. Never accelerate hard with a cold engine.

---

6. After warming up the engine, turn off the starter (choke) completely.

**NOTE:** \_\_\_\_\_

- The engine is warm when it responds normally to the throttle with the starter turned off. To avoid the possibility of excessive exhaust emissions, never leave the starter circuit on longer than necessary. The length of time the starter is needed depends upon the ambient temperature. Warm ambient temperatures (above 10°C/50°F) require about 7 seconds of starter use. Cold ambient temperatures (below 10°C/50°F) require about 35 seconds with the starter turned on, then about 2.5 minutes with the starter in the halfway position.
  - For maximum engine life, always warm up the engine before starting off. Never accelerate hard with a cold engine.
-

# OPERATION AND IMPORTANT RIDING POINTS

## Starting a warm engine

EAU01258

The starter (choke) is not required when the engine is warm.

EC000046

### CAUTION

See the “Engine break-in” section prior to operating the motorcycle for the first time.

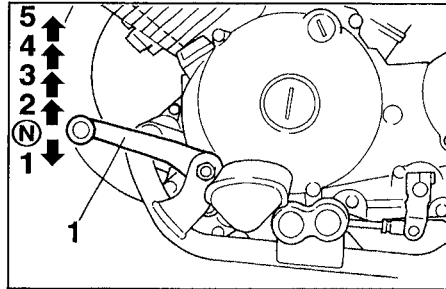

1. Shift pedal  
N. Neutral

EAU00423

## Shifting

The transmission lets you control the amount of power you have available at a given speed for starting, accelerating, climbing hills, etc. The use of the shift pedal is shown in the illustration.

To shift into neutral, depress the shift pedal repeatedly until it reaches the end of its travel, then raise the pedal slightly.

EC000048

### CAUTION

- Do not coast for long periods with the engine off, and do not tow the motorcycle a long distance. Even with gears in neutral, the transmission is only properly lubricated when the engine is running. Inadequate lubrication may damage the transmission.
- Always use the clutch when changing gears. The engine, transmission, and driveline are not designed to withstand the shock of forced shifting and can be damaged by shifting without using the clutch.

# OPERATION AND IMPORTANT RIDING POINTS

EAU01205

## To start out and accelerate

1. Pull the clutch lever to disengage the clutch.
2. Shift into first gear. The neutral indicator light should go out.
3. Open the throttle gradually, and at the same time, release the clutch lever slowly.
4. At the recommended shift point in the table on page 5-5, close the throttle, and at the same time, quickly pull in the clutch lever.
5. Shift into second gear. (Be careful not to shift into neutral.)
6. Open the throttle part way and gradually release the clutch lever.
7. Follow the same procedure when shifting to the next higher gear.  
Always shift gears at the recommended shift points.

EAU00427

## To decelerate

1. Apply both the front and the rear brakes at the same time to slow the motorcycle.
2. When the motorcycle reaches 20 km/h (12.5 mi/h), shift into first gear. Any time the engine is about to stall or runs very roughly, pull in the clutch and use the brakes to stop.
3. When the motorcycle is almost completely stopped, shift into neutral. The neutral indicator light should come on.

EAU00429

## Recommended shift point

	Acceleration shift point km/h (mi/h)	Deceleration shift point km/h (mi/h)
1st → 2nd	16 (9.9)	20 (12.5)
2nd → 3rd	24 (14.9)	20 (12.5)
3rd → 4th	32 (19.9)	20 (12.5)
4th → 5th	40 (24.9)	20 (12.5)

# OPERATION AND IMPORTANT RIDING POINTS

## Engine break-in

EAU00436

There is never a more important period in the life of your motorcycle than the period between zero and 1,000 km (600 mi). For this reason we ask that you carefully read the following material. Because the engine is brand new, you must not put an excessive load on it for the first 1,000 km (600 mi). The various parts in the engine wear and polish themselves to the correct operating clearances. During this period, prolonged full throttle operation, or any condition which might result in excessive heating of the engine, must be avoided.

### 0 ~ 150 km (0 ~ 90 mi)

Avoid operation above 1/3 throttle. Stop the engine and let it cool for 5 to 10 minutes after every hour of operation. Vary the speed of the motorcycle from time to time. Do not operate it at one set throttle position.

EAU00444

### 150 ~ 500 km (90 ~ 300 mi)

Avoid prolonged operation above 1/2 throttle. Rev the motorcycle freely through the gears, but do not use full throttle at any time.

### 500 ~ 1,000 km (300 ~ 600 mi)

Avoid cruising speeds in excess of 3/4 throttle.

EC000056

#### **CAUTION:**

**After 1,000 km (600 mi) of operation, be sure to replace the engine oil, oil filter and final gear oil.**

### 1,000 km (600 mi) and beyond

Avoid prolonged full-throttle operation. Vary speed occasionally.

EC000049

#### **CAUTION:**

**If any engine trouble should occur during the break-in period, consult a Yamaha dealer immediately.**



# OPERATION AND IMPORTANT RIDING POINTS

---

EAU00460

## Parking

When parking the motorcycle, stop the engine and remove the ignition key.

EW000058

### **WARNING**

**The exhaust system is hot. Park the motorcycle in a place where pedestrians or children are not likely to touch the motorcycle. Do not park the motorcycle on a slope or soft ground; the motorcycle may overturn.**

---

# PERIODIC MAINTENANCE AND MINOR REPAIR

Periodic maintenance .....	6-1	Brake light switch adjustment .....	6-22
Tool kit .....	6-1	Checking the front brake pads and rear brake shoes .....	6-22
Periodic maintenance chart for emission control system .....	6-3	Inspecting the brake fluid level.....	6-23
General maintenance and lubrication chart.....	6-5	Brake fluid replacement .....	6-24
Spark plugs .....	6-8	Cable inspection and lubrication .....	6-24
Canister (for California only).....	6-9	Throttle cable and grip lubrication.....	6-24
Engine oil.....	6-10	Brake and shift pedal lubrication.....	6-25
Final gear oil.....	6-12	Brake and clutch lever lubrication .....	6-25
Air filter .....	6-13	Sidestand lubrication.....	6-25
Carburetor adjustment.....	6-15	Front fork inspection .....	6-26
Throttle cable free play inspection.....	6-15	Steering inspection .....	6-26
Valve clearance adjustment .....	6-16	Wheel bearings .....	6-27
Tires .....	6-16	Battery.....	6-27
Wheels .....	6-18	Fuse replacement .....	6-29
Accessories or replacement parts .....	6-19	Headlight bulb replacement .....	6-29
Clutch lever free play adjustment.....	6-19	Turn signal and taillight bulb replacement .....	6-31
Front brake lever free play adjustment.....	6-20	Troubleshooting .....	6-31
Rear brake pedal height and free play adjustment.....	6-21	Troubleshooting chart .....	6-32

EAU00463

Periodic inspection, adjustment, and lubrication will keep your motorcycle in the safest and most efficient condition possible. Safety is an obligation of the motorcycle owner. The most important points of motorcycle inspection, adjustment, and lubrication are explained in the following pages.

**“Maintenance, replacement, or repair of the emission control devices and systems may be performed by any repair establishment or individual using any part which is certified (if applicable)”.**

EW000060

## **! WARNING**

**If you are not familiar with motorcycle service, this work should be done by a Yamaha dealer.**

EAU00467

## PERIODIC MAINTENANCE

PROPER PERIODIC MAINTENANCE OF YOUR MOTORCYCLE IS IMPORTANT IN ORDER TO ENJOY LONG, PLEASURABLE SERVICE. ESPECIALLY IMPORTANT ARE THE MAINTENANCE SERVICES RELATED TO EMISSIONS CONTROL. THESE CONTROLS NOT ONLY FUNCTION TO ENSURE CLEANER AIR BUT ARE ALSO VITAL TO PROPER ENGINE OPERATION AND MAXIMUM PERFORMANCE. IN THE FOLLOWING TABLES OF PERIODIC MAINTENANCE, THE SERVICES RELATED TO EMISSIONS CONTROL ARE GROUPED SEPARATELY. THESE SERVICES REQUIRE SPECIALIZED DATA, KNOWLEDGE, AND EQUIPMENT. YAMAHA DEALERS ARE TRAINED AND EQUIPPED TO PERFORM THESE PARTICULAR SERVICES.

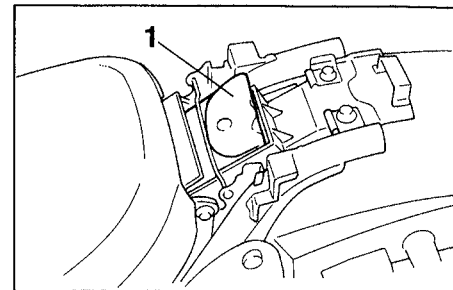

1. Tool kit

EAU00468

## Tool kit

The service information included in this manual is intended to provide you, the owner, with the necessary information for completing some of your own preventive maintenance and minor repairs. The tools provided in the owner's tool kit are to assist you in the performance of periodic maintenance. However, some other tools such as a torque wrench are also necessary to perform the maintenance correctly.

# PERIODIC MAINTENANCE AND MINOR REPAIR

---

---

**NOTE:** \_\_\_\_\_

If you do not have necessary tools required during a service operation, take your motorcycle to a Yamaha dealer for service.

---

EW000062

 **WARNING** \_\_\_\_\_

**Modifications to this motorcycle not approved by Yamaha may cause loss of performance, excessive emissions, and render it unsafe for use. Consult a Yamaha dealer before attempting any changes.**

---

# PERIODIC MAINTENANCE AND MINOR REPAIR

EAU00471

## PERIODIC MAINTENANCE CHART FOR EMISSION CONTROL SYSTEM

No.	ITEM	ROUTINE	INITIAL	ODOMETER READINGS				
			1,000 km (600 mi) or 1 month	**1 7,000 km (4,400 mi) or 7 months	**2 13,000 km (8,200 mi) or 13 months	19,000 km (12,000 mi) or 19 months	**3 25,000 km (15,800 mi) or 25 months	31,000 km (19,600 mi) or 31 months
1	* Valve clearance	• Check and adjust valve clearance when engine is cold.	√	√	√	√	√	√
2	Spark plug	• Check condition. • Adjust gap and clean. • Replace at 13,000 km (8,200 mi) (or 13 months) and thereafter every 12,000 km (7,600 mi) (or 12 months).		√	Replace	√	Replace	√
3	* Crankcase ventilation system	• Check ventilation hose for cracks or damage. • Replace if necessary.		√	√	√	√	√
4	* Fuel line	• Check fuel hose and vacuum pipe for cracks or damage. • Replace if necessary.		√	√	√	√	√
5	* Exhaust system	• Check for leakage. • Retighten if necessary. • Replace gasket(s) if necessary.		√	√	√	√	√
6	* Carburetor Synchronization	• Adjust synchronization of carburetors.	√	√	√	√	√	√
7	* Idle speed	• Check and adjust engine idle speed. • Adjust cable free play.		√	√	√	√	√
8	* Evaporative emission control system**	• Check control system for damage. • Replace if necessary.				√		√

\* Since these items require special tools, data and technical skills, they should be serviced by a Yamaha dealer.

\*\* California only.

# PERIODIC MAINTENANCE AND MINOR REPAIR

---

---

**NOTE:**

For farther odometer reading beyond those listed, repeat the above maintenance at the period established; \*\*1: Every 6,000 km (3,800 mi) and \*\*2: Every 12,000 km (7,600 mi) and \*\*3: Every 24,000 km (15,200 mi) intervals.

---

# PERIODIC MAINTENANCE AND MINOR REPAIR

EAU00472

## GENERAL MAINTENANCE AND LUBRICATION CHART

No.	ITEM	ROUTINE	TYPE	INITIAL	ODOMETER READINGS					
				1,000 km (600 mi) or 1 month	**1 7,000 km (4,400 mi) or 7 months	**2 13,000 km (8,200 mi) or 13 months	19,000 km (12,000 mi) or 19 months	**3 25,000 km (15,800 mi) or 25 months	31,000 km (19,600 mi) or 31 months	
1	Engine oil	• Warm-up engine before draining.	See page 6-10.	√	√	√	√	√	√	
2	* Oil filter	• Replace	-	√		√		√		
3	* Air filter	• Clean with compressed air. • Replace if necessary.	-		√	√	√	√	√	
4	* Brake system	• Adjust free play. • Replace pads if necessary. (Front) • Replace shoes if necessary. (Rear)	-	√	√	√	√	√	√	
5	* Clutch	• Adjust free play.	-	√	√	√	√	√	√	
6	* Final gear oil	• Check oil level and leakage. • Replace every 24,000 km (15,200 mi) or 24 months.	SAE 80 API GL-4 hypoid gear oil	Replace		Check		√		
7	Control and meter cable	• Apply chain lube thoroughly.	Yamaha chain and cable lube or SAE 10W30 motor oil	√	√	√	√	√	√	
8	* Swingarm pivot bearing	• Check bearing assembly for looseness. • Moderately repack every 24,000 km (15,200 mi).	Molybdenum disulfide grease					Repack		
9	Brake/Clutch lever pivot shaft	• Apply chain lube lightly.	Yamaha chain and cable lube or SAE 10W30 motor oil		√	√	√	√	√	

# PERIODIC MAINTENANCE AND MINOR REPAIR

No.	ITEM	ROUTINE	TYPE	INITIAL	ODOMETER READINGS					
				1,000 km (600 mi) or 1 month	**1 7,000 km (4,400 mi) or 7 months	**2 13,000 km (8,200 mi) or 13 months	19,000 km (12,000 mi) or 19 months	**3 25,000 km (15,800 mi) or 25 months	31,000 km (19,600 mi) or 31 months	
10	* Brake pedal and shift pedal shaft	<ul style="list-style-type: none"> <li>Lubricate.</li> <li>Apply chain lube lightly.</li> </ul>	Yamaha chain and cable lube or SAE 10W30 motor oil		√	√	√	√	√	
11	* Sidestand pivot	<ul style="list-style-type: none"> <li>Check operation and lubricate.</li> <li>Apply chain lube lightly.</li> </ul>	Yamaha chain and cable lube or SAE 10W30 motor oil		√	√	√	√	√	
12	* Front fork oil	<ul style="list-style-type: none"> <li>Check operation and leakage.</li> </ul>	-		√	√	√	√	√	
13	* Steering bearings	<ul style="list-style-type: none"> <li>Check bearing assembly for looseness.</li> <li>Moderately repack every 24,000 km (15,200 mi).</li> </ul>	Lithium soap base grease		√	√	√	<b>Repack</b>	√	
14	* Wheel bearings	<ul style="list-style-type: none"> <li>Check bearing for smooth rotation.</li> </ul>	-		√	√	√	√	√	
15	Battery	<ul style="list-style-type: none"> <li>Check specific gravity and breather pipe for proper operation.</li> </ul>	-		√	√	√	√	√	
16	* Sidestand switch	<ul style="list-style-type: none"> <li>Check and clean or replace if necessary.</li> </ul>	-	√	√	√	√	√	√	

\* Since these items require special tools, data and technical skills, they should be serviced by a Yamaha dealer.

**NOTE:**  
For farther odometer reading beyond those listed, repeat the above maintenance at the period established; \*\*1: Every 6,000 km (3,800 mi) and \*\*2: Every 12,000 km (7,600 mi) and \*\*3: Every 24,000 km (15,200 mi) intervals.



# PERIODIC MAINTENANCE AND MINOR REPAIR

---

EAU01450

## NOTE:

- The air filter needs more frequent service if you are riding in unusually wet or dusty areas.
  - Hydraulic brake system
    - When disassembling the master cylinder or caliper cylinder, always replace the brake fluid. Check the brake fluid level regularly and fill as required.
    - Replace the oil seals on the inner parts of the master cylinder and caliper cylinder every two years.
    - Replace the brake hoses every four years or if cracked or damaged.
-

# PERIODIC MAINTENANCE AND MINOR REPAIR

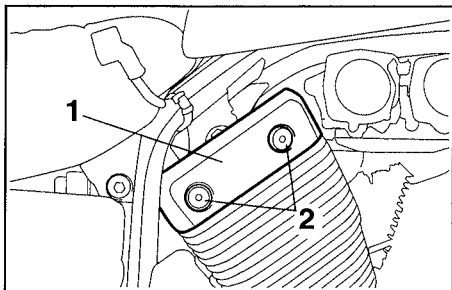

1. Cylinder head cover
2. Screw (× 2)

EAU01486

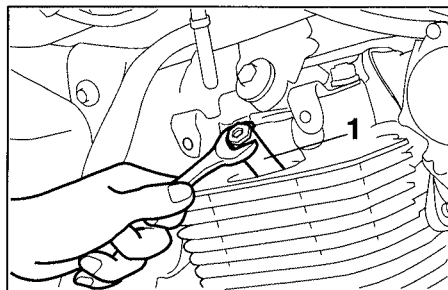

1. Spark plug wrench
3. Use the spark plug wrench in the tool kit to remove the spark plugs as shown.

## Inspection

The spark plug is an important engine component and is easy to inspect. The condition of the spark plug can indicate the condition of the engine. Normally, all spark plugs from the same engine should have the same color on the white insulator around the center electrode. The ideal color at this point is a medium-to-light tan color for a motorcycle that is being ridden normally. If one spark plug shows a distinctly differ-

ent color, there could be something wrong with the engine. Do not attempt to diagnose such problems yourself. Instead, take the motorcycle to a Yamaha dealer. You should periodically remove and inspect the spark plugs because heat and deposits will cause any spark plug to slowly break down and erode. If electrode erosion becomes excessive, or if carbon and other deposits are excessive, you should replace the spark plug with the specified plug.

Specified spark plug:  
BP7ES (NGK) or  
W22EP-U (DENSO)

## Spark plugs

### Removal

1. Remove the rear right and front left cylinder head covers by removing the screws.
2. Remove the spark plug caps.

# PERIODIC MAINTENANCE AND MINOR REPAIR

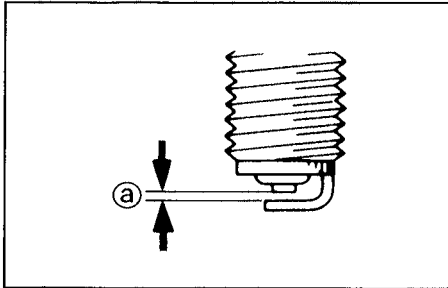

a. Spark plug gap

## Installation

1. Measure the electrode gap with a wire thickness gauge and, if necessary, adjust the gap to specification.

Spark plug gap:  
0.7 ~ 0.8 mm (0.028 ~ 0.031 in)

2. Clean the gasket surface. Wipe off any grime from the threads.
3. Install the spark plug and tighten it to the specified torque.

Tightening torque:  
Spark plug:  
20 Nm (2.0 m·kg, 14 ft·lb)

## NOTE:

If a torque wrench is not available when you are installing a spark plug, a good estimate of the correct torque is 1/4 to 1/2 turn past finger tight. Have the spark plug tightened to the specified torque as soon as possible.

4. Install the spark plug caps, the cylinder head covers and the screws.

## EMMISION HOSE ROUTING

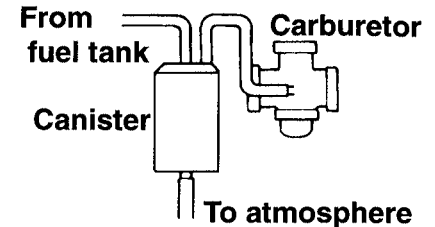

EAU00499

## Canister (for California only)

This model is equipped with a canister to prevent the discharging of fuel vapor into the atmosphere. Before using this motorcycle, be sure to check the following:

- Check each hose connection.
- Check each hose and canister for cracks or damage. Replace if damaged.
- Make sure the canister breather is not blocked. Clean it if necessary.

# PERIODIC MAINTENANCE AND MINOR REPAIR

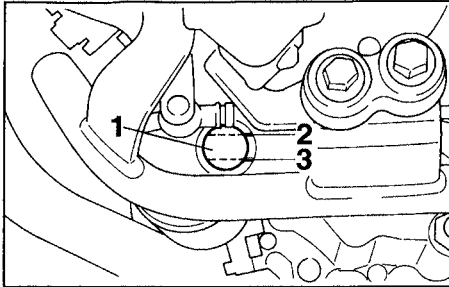

1. Oil level window
2. Maximum level mark
3. Minimum level mark

EAU00514

## Engine oil

### Oil level inspection

1. Place the motorcycle on a level place and hold it in an upright position. Warm up the engine for several minutes.

#### NOTE: \_\_\_\_\_

Be sure the motorcycle is positioned straight up when checking the oil level. A slight tilt toward the side can result in false readings.

2. With the engine stopped, check the oil level through the level window located at the lower part of the left side crankcase cover.

#### NOTE: \_\_\_\_\_

Wait a few minutes until the oil level settles before checking.

3. The oil level should be between the maximum and minimum marks. If the level is low, fill the engine with sufficient oil to the specified level.

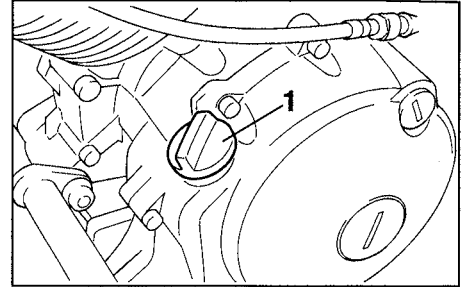

1. Engine oil filler cap

### Engine oil and oil filter element replacement

1. Warm up the engine for a few minutes.
2. Stop the engine. Place an oil pan under the engine and remove the oil filler cap.

# PERIODIC MAINTENANCE AND MINOR REPAIR

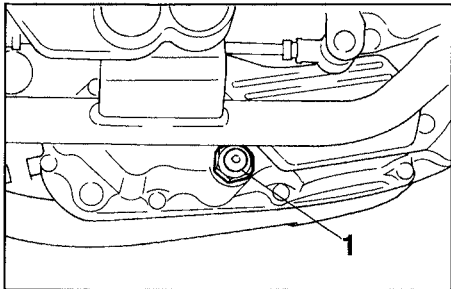

1. Engine oil drain plug

3. Remove the drain plug and drain the oil.

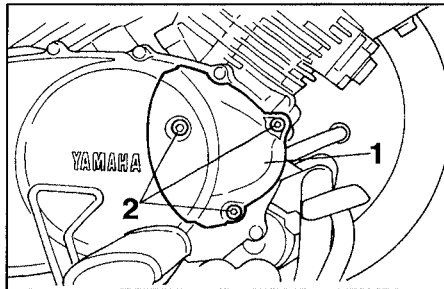

1. Oil filter cover  
2. Bolt (x 3)

4. Remove the oil filter bolts, oil filter and O-ring.
5. Reinstall the drain plug and tighten it to the specified torque.

Tightening torque:

Drain plug:

43 Nm (4.3 m·kg, 31 ft·lb)

6. Install the new oil filter, new O-ring and the filter cover. Then tighten the oil filter bolts to the specified torque.

Tightening torque:

Oil filter bolts:

10 Nm (1.0 m·kg, 7.2 ft·lb)

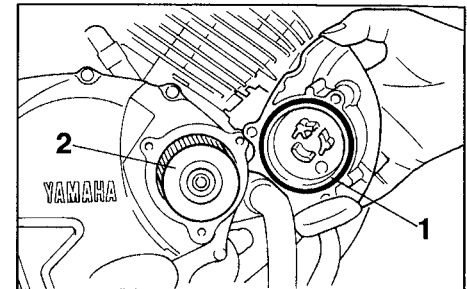

1. O-ring  
2. Oil filter element

**NOTE:**

Make sure the O-ring is seated properly.

7. Fill the engine with oil. Install the oil filler cap and tighten it.

Recommended oil:

See page 8-1

Oil quantity:

Total amount:

3.2 L (2.8 Imp qt, 3.4 US qt)

Periodic oil change:

2.6 L (2.3 Imp qt, 2.7 US qt)

With oil filter replacement:

2.8 L (2.5 Imp qt, 3.0 US qt)

# PERIODIC MAINTENANCE AND MINOR REPAIR

EC000066

## CAUTION:

- Do not put in any chemical additives. Engine oil also lubricates the clutch and additives could cause clutch slippage.
- Be sure no foreign material enters the crankcase.

8. Start the engine and warm it up for a few minutes. While warming up, check for oil leakage. If oil leakage is found, stop the engine immediately and check for the cause.

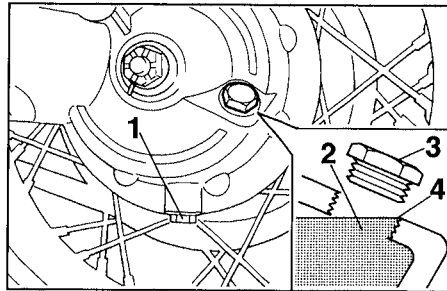

1. Final gear oil drain plug
2. Final gear oil
3. Final gear oil filler bolt
4. Correct level

EAU00542

EW000066

## Final gear oil

### WARNING

Do not let foreign material enter the final gear case. Be sure oil does not get on the tire or wheel.

### Oil level inspection

1. Place the motorcycle on a level place and hold it in an upright position. The engine should be cool at ambient temperature.

2. Remove the oil filler bolt and check the oil level. The oil level should be at the brim of the filler hole. Add the recommended oil if necessary.

### Oil replacement

1. Place an oil pan under the final gear case.
2. Remove the oil filler bolt and drain plug to drain the oil.
3. Reinstall and tighten the drain plug to the specified torque.

Tightening torque:

Drain plug:

23 Nm (2.3 m·kg, 17 ft·lb)

4. Fill the gear case to the brim of the filler hole with the recommended oil.

# PERIODIC MAINTENANCE AND MINOR REPAIR

Final gear case capacity:

0.19 L (0.17 Imp qt, 0.20 US qt)

Recommended oil:

SAE 80 API GL-4 Hypoid gear oil

If desired, an SAE 80W90 hypoid gear oil may be used for all conditions.

## NOTE:

“GL-4” is a quality and additive rating. Hypoid gear oils rated “GL-5” or “GL-6” may also be used.

5. Reinstall and tighten the filler bolt to the specified torque.

Tightening torque:

Oil filler bolt:

23 Nm (2.3 m·kg, 17 ft·lb)

6. After replacing the final gear oil, be sure to check for oil leakage.

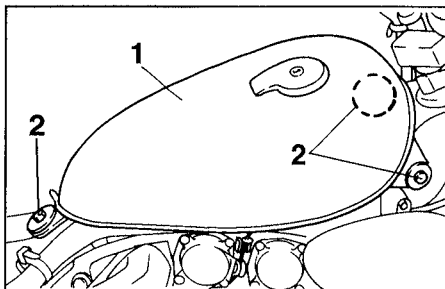

1. Fuel tank
2. Bolt (× 3)

## Air filter

The air filter should be cleaned at the specified intervals. It should be cleaned more frequently if you are riding in unusually wet or dusty areas.

1. Remove the seats.
2. Remove the fuel tank bolts.

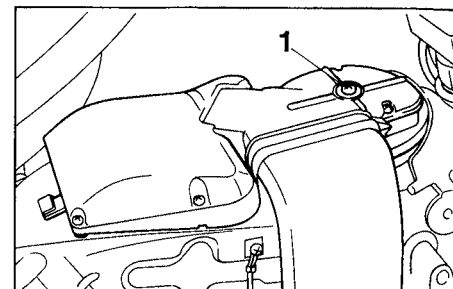

1. Screw

3. Lift the front of the fuel tank upward and position it away from the air filter. (Do not remove the fuel tank.)

## WARNING

- Support the fuel tank carefully during this procedure.
- Do not tilt the fuel tank too much or pull it too hard because the fuel hose connections may become loose causing fuel leakage.

4. Remove the air filter case cover screw.

EAU01473

EW000071

# PERIODIC MAINTENANCE AND MINOR REPAIR

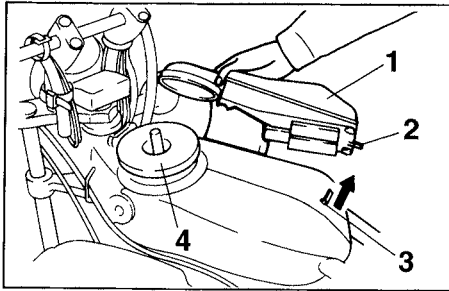

1. Air filter case cover
2. Tab
3. Holder
4. Air filter

5. Slide the air filter case cover so as to unhook the tab on the rear of the cover from the holder on the frame. Then lift the air filter case cover upward without removing it.

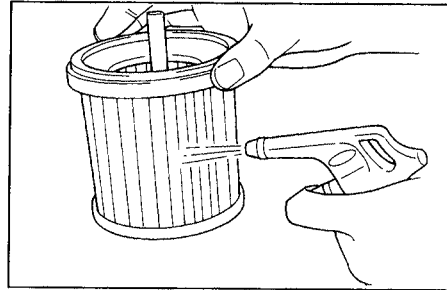

6. Pull out the air filter and tap it lightly to remove most of the dust and dirt. Blow out the remaining dirt with compressed air as shown. If the air filter is damaged, replace it.

7. Reassemble by reversing the removal procedure.

EC000082

## CAUTION:

- Make sure the air filter is properly seated in the air filter case.
- The engine should never be run without the air filter installed. Excessive piston and/or cylinder wear may result.



# PERIODIC MAINTENANCE AND MINOR REPAIR

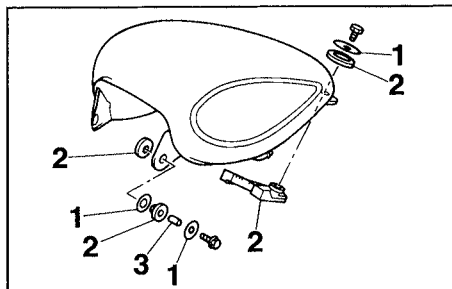

1. Washer
2. Rubber damper
3. Spacer

EW000131

## **⚠ WARNING**

Make sure that the fuel hoses and vacuum hose are properly connected, in place and not pinched. If a hose is damaged, be sure to replace it.

EC000086

## **CAUTION:**

When reinstalling the fuel tank holding bolts, make sure that the washers, damper rubbers and spacers are positioned properly.

EAU00628

## Carburetor adjustment

The carburetors are important parts of the engine and emission control system. Adjusting should be left to a Yamaha dealer with the professional knowledge, specialized data and equipment to do so properly.

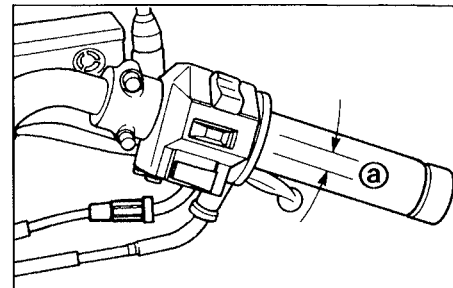

a. Free play

EAU00635

## Throttle cable free play inspection

There should be a free play of 3 ~ 5 mm (0.12 ~ 0.20 in) at the throttle grip. If the free play is incorrect, ask a Yamaha dealer to make this adjustment.

# PERIODIC MAINTENANCE AND MINOR REPAIR

EAU00637

## Valve clearance adjustment

The correct valve clearance changes with use, resulting in improper fuel/air supply or engine noise. To prevent this, the valve clearance must be adjusted regularly. This adjustment however, should be left to a professional Yamaha service technician.

EAU00645

## Tires

To ensure maximum performance, long service, and safe operation, note the following:

### Tire air pressure

Always check and adjust the tire pressure before operating the motorcycle.

EW000082

### **WARNING**

**Tire inflation pressure should be checked and adjusted when the temperature of the tire equals the ambient air temperature. Tire inflation pressure must be adjusted according to total weight of cargo, rider, passenger, and accessories (fairing, saddlebags, etc. if approved for this model), and vehicle speed.**

Maximum load*	220 kg (485 lb): XV535 219 kg (483 lb): XV535C	
Cold tire pressure	Front	Rear
Up to 90 kg (198 lb) load*	200 kPa (2.00 kgf/cm <sup>2</sup> , 29 psi)	225 kPa (2.25 kgf/cm <sup>2</sup> , 33 psi)
90 kg (198 lb) load ~ Maximum load*	200 kPa (2.00 kgf/cm <sup>2</sup> , 29 psi)	250 kPa (2.50 kgf/cm <sup>2</sup> , 36 psi)

\* Load is the total weight of cargo, rider, passenger, and accessories.

# PERIODIC MAINTENANCE AND MINOR REPAIR

EW000083

## ⚠ WARNING

Proper loading of your motorcycle is important for several characteristics of your motorcycle, such as handling, braking, performance and safety. Do not carry loosely packed items that can shift. Securely pack your heaviest items close to the center of the motorcycle, and distribute the weight evenly from side to side. Properly adjust the suspension for your load, and check the condition and pressure of your tires. **NEVER OVERLOAD YOUR MOTORCYCLE.** Make sure the total weight of the cargo, rider, passenger, and accessories (fairing, saddlebags, etc. if approved for this model) does not exceed the maximum load of the motorcycle. Operation of an overloaded motorcycle could cause tire damage, an accident, or even injury.

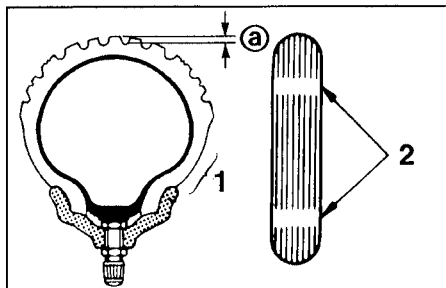

1. Side wall
2. Wear indicator
- a. Tread depth

### Tire inspection

Always check the tires before operating the motorcycle. If a tire tread shows crosswise lines (minimum tread depth), if the tire has a nail or glass fragments in it, or if the side wall is cracked, contact a Yamaha dealer immediately and have the tire replaced.

### FRONT

Manufacturer	Size	Type
Bridgestone	3.00-19 49S	L303A
Dunlop	3.00-19 49S	F14G

### REAR

Manufacturer	Size	Type
Bridgestone	140/90-15 M/C 70S	G508
Dunlop	140/90-15 M/C 70S	K425

Minimum tire tread depth (front and rear)	1.0 mm (0.04 in)
---	------------------

# PERIODIC MAINTENANCE AND MINOR REPAIR

EAU00680

EAU00685

## WARNING

- It is dangerous to ride with a worn-out tire. When a tire tread begins to show lines, have a Yamaha dealer replace the tire immediately. Brakes, tires, and related wheel parts replacement should also be left to a Yamaha dealer.
- Patching a punctured tube is not recommended. If it is absolutely necessary to do so, use great care and replace the tube as soon as possible with a good quality replacement.

## Wheels

To ensure maximum performance, long service, and safe operation, note the following:

- Always inspect the wheels before a ride. Check for cracks, bends or warpage of the wheel. Be sure the spokes are tight and undamaged. If any abnormal condition exists in a wheel, consult a Yamaha dealer. Do not attempt even small repairs to the wheel. If a wheel is deformed or cracked, it must be replaced.
- Tires and wheels should be balanced whenever either one is changed or replaced. Failure to have a wheel balanced can result in poor performance, adverse handling characteristics, and shortened tire life.
- Ride at moderate speeds after changing a tire since the tire surface must first be broken in for it to develop its optimal characteristics.

# PERIODIC MAINTENANCE AND MINOR REPAIR

EAU00691

## Accessories or replacement parts

EW000098

### **⚠ WARNING**

This motorcycle is not designed to pull a trailer or to be attached to a sidecar. The accessories or replacement parts you choose for your motorcycle should be designed specifically for it, and they must be securely mounted to maintain the inherent stability of the original design. Genuine Yamaha Parts and Accessories are designed and tested to be compatible with your motorcycle. Please consider Genuine Yamaha Parts and Accessories before making an accessory purchase. Use of non-Yamaha-approved parts or accessories may cause loss of handling stability and riding safety. Since Yamaha cannot control the quality of parts or accessories manufactured by other companies, Yamaha cannot be held liable for

any consequences caused by the use of items which have not been approved by Yamaha.

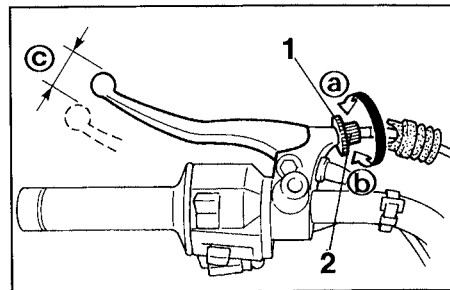

1. Locknut
2. Adjusting bolt
- c. Free play

EAU00694

## Clutch lever free play adjustment

The clutch lever free play should be adjusted to 10 ~ 15 mm (0.39 ~ 0.59 in).

1. Loosen the locknut at the clutch lever.
2. Turn the adjusting bolt at the clutch lever in direction ① to increase free play or in direction ② to decrease free play.
3. Tighten the locknut at the clutch lever.

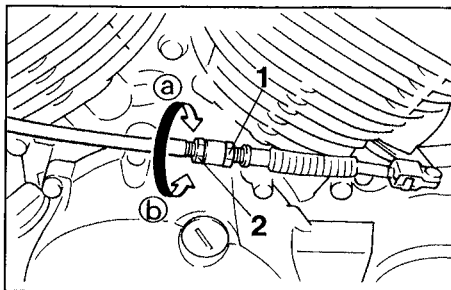

1. Locknut
2. Adjusting nut

If the specified free play cannot be obtained, proceed with the following steps.

4. Loosen the locknut at the clutch lever.
5. Turn the adjusting bolt at the clutch lever in direction (a) to loosen the cable.
6. Loosen the locknut at the crankcase side.
7. Turn the adjusting nut at the crankcase in direction (a) to increase free play or in direction (b) to decrease free play.
8. Tighten the locknut at the crankcase and the clutch lever.

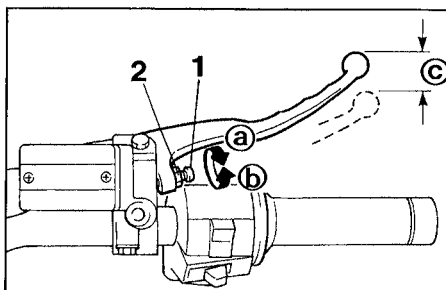

1. Adjusting bolt
2. Locknut
- c. Free play

EAU00696

## Front brake lever free play adjustment

The free play at the front brake lever should be 2 ~ 5 mm (0.08 ~ 0.20 in).

1. Loosen the locknut.
2. Turn the adjusting bolt in direction (a) to increase free play or in direction (b) to decrease free play.
3. After adjusting, tighten the locknut.

### **WARNING**

- Check the brake lever free play. Be sure the brake is working properly.
- A soft or spongy feeling in the brake lever can indicate the presence of air in the brake system. This air must be removed by bleeding the brake system before the motorcycle is operated. Air in the system will cause greatly diminished braking capability and can result in loss of control and an accident. Have a Yamaha dealer inspect and bleed the system if necessary.

# PERIODIC MAINTENANCE AND MINOR REPAIR

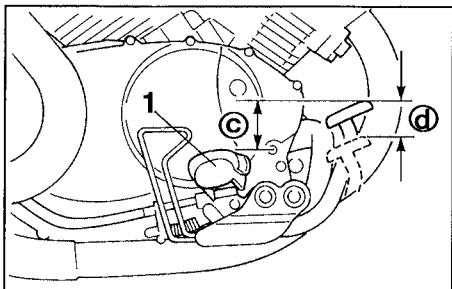

- 1. Footrest
- c. Pedal height
- d. Free play

## Rear brake pedal height and free play adjustment

EAU00711

EW000104

### **⚠ WARNING**

It is advisable to have a Yamaha dealer make this adjustment.

The brake pedal height should be adjusted before adjusting the brake pedal free play.

### **Pedal height**

The brake pedal should be positioned approximately 38 mm (1.5 in) above the top of the footrest.

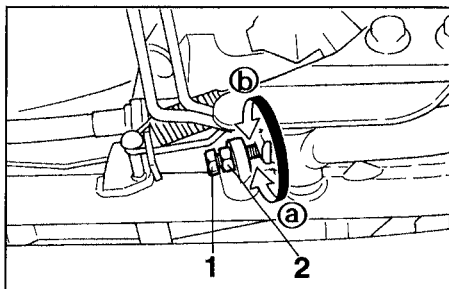

- 1. Adjusting bolt
- 2. Locknut

- 1. Loosen the locknut.
- 2. Turn the adjusting bolt in direction **Ⓐ** to raise pedal height or in direction **Ⓑ** to lower pedal height.
- 3. Tighten the locknut.

EW000105

### **⚠ WARNING**

After adjusting the pedal height, adjust brake pedal free play.

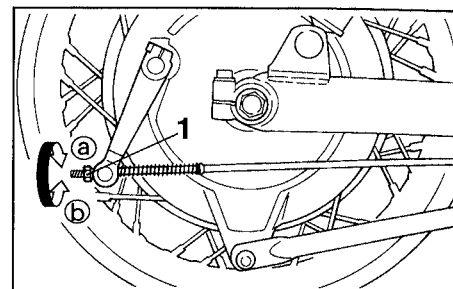

- 1. Adjusting nut

### **Free play**

The brake pedal free play should be adjusted to 20 ~ 30 mm (0.8 ~ 1.2 in) at the brake pedal end. Turn the adjusting nut on the brake rod in direction **Ⓐ** to increase free play or in direction **Ⓑ** to decrease free play.

# PERIODIC MAINTENANCE AND MINOR REPAIR

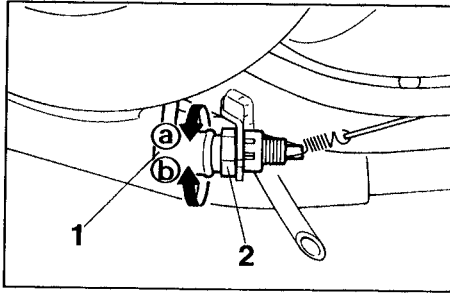

1. Brake light switch
2. Adjusting nut

EAU00713

## Brake light switch adjustment

The rear brake light switch is activated by the brake pedal and is properly adjusted when the brake light comes on just before braking takes effect. To adjust the rear brake light switch, hold the switch body so it does not rotate while turning the adjusting nut. Turn the adjusting nut in direction ① to make the brake light come on earlier. Turn the adjusting nut in direction ② to make the brake light come on later.

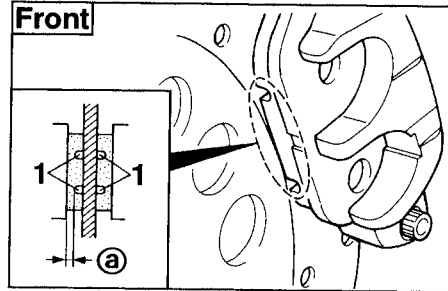

1. Wear indicator groove
- a. Wear limit

EAU00720

## Checking the front brake pads and rear brake shoes

EAU01119

### Front brake

Wear indicator grooves are provided on each brake pad. These indicators allow checking of brake pad wear without disassembling the brake. Inspect the grooves. If they have almost disappeared, ask a Yamaha dealer to replace the pads.

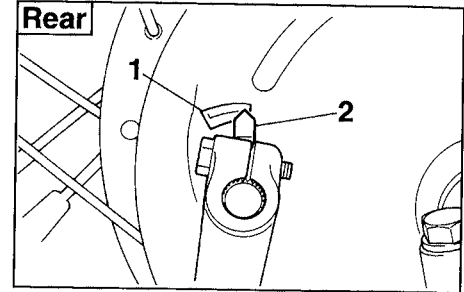

1. Wear limit
2. Wear indicator

EAU00727\*

### Rear brake

Apply the brake and inspect the wear indicator.

If the indicator reaches the wear limit line, ask a Yamaha dealer to replace the shoes.



# PERIODIC MAINTENANCE AND MINOR REPAIR

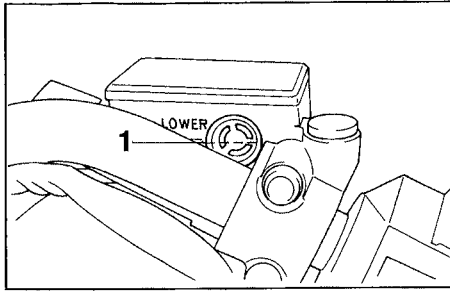

1. Minimum level mark

EAU00732

## Inspecting the brake fluid level

Insufficient brake fluid may let air enter the brake system, possibly causing the brakes to become ineffective.

Before riding, check that the brake fluid is above the minimum level and fill when necessary.

Observe these precautions:

- When checking the fluid level, make sure the top of the master cylinder is level by turning the handlebars.

- Use only the designated quality brake fluid. Otherwise, the rubber seals may deteriorate, causing leakage and poor brake performance.

Recommended brake fluid: DOT 4

### NOTE:

If DOT 4 is not available, DOT 3 can be used.

- Brake fluid may deteriorate painted surfaces or plastic parts. Always clean up spilled fluid immediately.
  - Have a Yamaha dealer check the cause if the brake fluid level goes down.
- Refill with the same type of brake fluid. Mixing fluids may result in a harmful chemical reaction and lead to poor brake performance.
  - Be careful that water does not enter the master cylinder when refilling. Water will significantly lower the boiling point of the fluid and may result in vapor lock.

## Brake fluid replacement

EAU00742

The brake fluid should be replaced only by trained Yamaha service personnel. Have the Yamaha dealer replace the following components during periodic maintenance or when they are damaged or leaking:

- oil seals (every two years)
- brake hoses (every four years)

## Cable inspection and lubrication

EAU01541

EW000111

### **! WARNING**

**Damage to the outer housing of cables may allow internal rusting and cause interference with cable movement. Replace damaged cables as soon as possible to prevent unsafe conditions.**

Lubricate the cables and cable ends. If a cable does not operate smoothly, ask a Yamaha dealer to replace it.

Recommended lubricant:  
Yamaha Chain and Cable Lube  
or SAE 10W30 motor oil

## Throttle cable and grip lubrication

EAU00773

The throttle twist grip assembly should be greased at the time that the cable is lubricated, since the grip must be removed to get at the end of the throttle cable. After removing the screws, hold the end of the cable up in the air and put in several drops of lubricant. With the throttle grip disassembled, coat the metal surface of the grip assembly with a suitable all-purpose grease.

# PERIODIC MAINTENANCE AND MINOR REPAIR

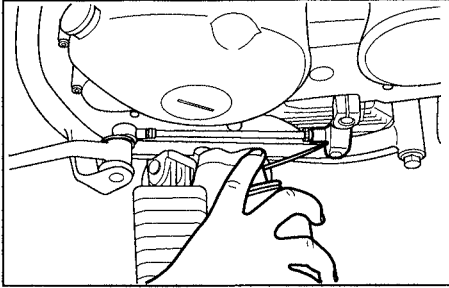

EAU00775

## Brake and shift pedal lubrication

Lubricate the pivoting parts.

Recommended lubricant:  
Yamaha Chain and Cable Lube  
or SAE 10W30 motor oil

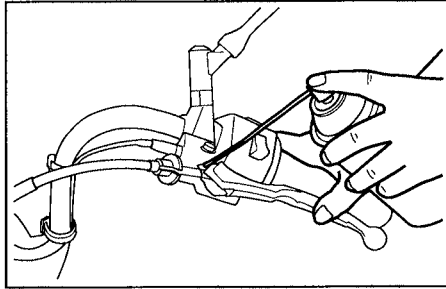

EAU00777

## Brake and clutch lever lubrication

Lubricate the pivoting parts.

Recommended lubricant:  
Yamaha Chain and Cable Lube  
or SAE 10W30 motor oil

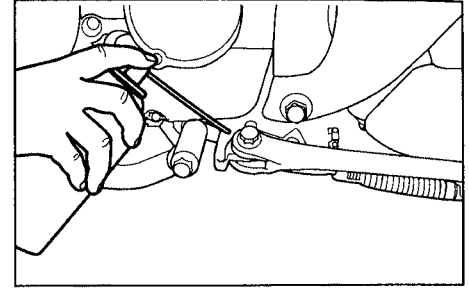

EAU01542

## Sidestand lubrication

Lubricate the sidestand pivoting point and metal-to-metal contact surfaces. Check that the sidestand moves up and down smoothly.

Recommended lubricant:  
Yamaha Chain and Cable Lube  
or SAE 10W30 motor oil

EW000113

### **WARNING**

**If the sidestand does not move smoothly, consult a Yamaha dealer.**

# PERIODIC MAINTENANCE AND MINOR REPAIR

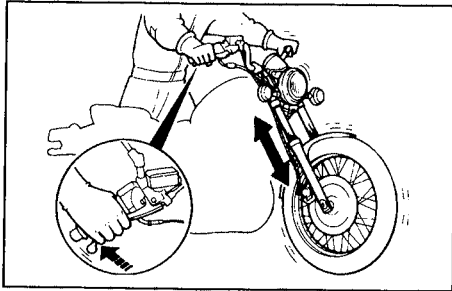

EAU00793

## Front fork inspection

EW000115

### **⚠ WARNING**

**Securely support the motorcycle so there is no danger of it falling over.**

### Visual check

Check for scratches or damage on the inner tube and excessive oil leakage from the front fork.

### Operation check

1. Place the motorcycle on a level place.
2. Hold the motorcycle in an upright position and apply the front brake.

3. Push down hard on the handlebars several times and check if the fork rebounds smoothly.

EC000098

### **CAUTION:**

**If any damage or unsmooth movement is found with the front fork, consult a Yamaha dealer.**

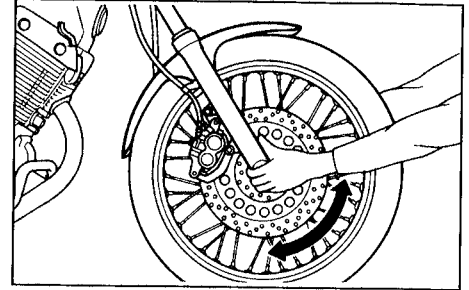

EAU00794

## Steering inspection

Periodically inspect the condition of the steering. Worn out or loose steering bearings may be dangerous. Place a stand under the engine to raise the front wheel off the ground. Hold the lower end of the front forks and try to move them forward and backward. If any free play can be felt, ask a Yamaha dealer to inspect and adjust the steering. Inspection is easier if the front wheel is removed.

EW000115

### **⚠ WARNING**

**Securely support the motorcycle so there is no danger of it falling over.**

# PERIODIC MAINTENANCE AND MINOR REPAIR

EAU01144

## Wheel bearings

If there is play in the front or rear wheel hub or if the wheel does not turn smoothly, have a Yamaha dealer inspect the wheel bearings.

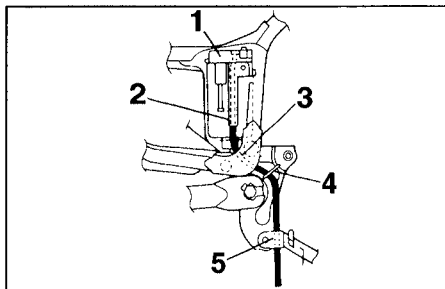

1. Battery
2. Pass through the battery case
3. Pass through the frame
4. Pass through the cable guide
5. Pass through the engine bracket

EAU00798

## Battery

Check the level of the battery electrolyte and make sure that the terminals are tight. Fill with distilled water if the electrolyte level is low. If the motorcycle is equipped with optional electrical accessories, the battery tends to discharge more quickly, so be sure to recharge it periodically.

EC000099

### CAUTION:

When inspecting the battery, be sure the breather hose is routed correctly. If the breather hose is positioned in such a way as to cause battery electrolyte or gas to exit onto the frame, structural and cosmetic damage to the motorcycle can occur.

# PERIODIC MAINTENANCE AND MINOR REPAIR

EW000116

## **! WARNING**

Battery electrolyte is poisonous and dangerous, causing severe burns, etc. It contains sulfuric acid. Avoid contact with skin, eyes or clothing.

### ANTIDOTE:

- **EXTERNAL:** Flush with water.
- **INTERNAL:** Drink large quantities of water or milk. Follow with milk of magnesia, beaten egg, or vegetable oil. Call a physician immediately.
- **EYES:** Flush with water for 15 minutes and get prompt medical attention.

Batteries produce explosive gases. Keep sparks, flame, cigarettes etc., away. Ventilate when charging or using in an enclosed space. Always shield your eyes when working near batteries. **KEEP OUT OF REACH OF CHILDREN.**

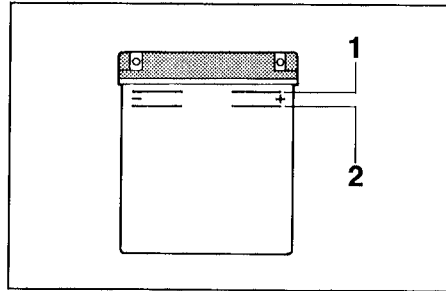

1. Maximum level mark
2. Minimum level mark

### Replenishing the battery fluid

A poorly maintained battery will corrode and discharge quickly. The battery fluid should be checked at least once a month. The level should be between the minimum level and maximum level marks. Use only distilled water if refilling is necessary.

EC000100

## **CAUTION**

Normal tap water contains minerals which are harmful to a battery; therefore, refill only with distilled water.

### Battery storage

- When the motorcycle will not be used for a month or longer, remove the battery, fully charge it and store it in a cool, dry place. Completely recharge the battery before reinstalling.
- If the battery will be stored for longer than two months, check the specific gravity of the fluid at least once a month and recharge the battery when it is too low.
- Always make sure the connections are correct when putting the battery back in the motorcycle. Make sure the breather hose is properly connected and is not damaged or obstructed.

# PERIODIC MAINTENANCE AND MINOR REPAIR

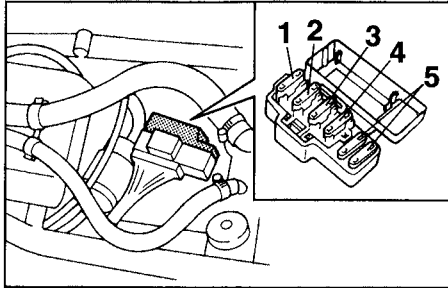

1. Main fuse
2. Headlight fuse
3. Signaling system fuse
4. Ignition fuse
5. Spare fuse (× 2)

EAU00818

## Fuse replacement

The fuse box is located under the rider seat.

If any fuse is blown, turn off the main switch and the switch of the circuit in question. Install a new fuse of the specified amperage. Turn on the switches and check if the electrical device operates. If the fuse immediately blows again, consult a Yamaha dealer.

EC000103

### CAUTION:

Do not use fuses of higher amperage rating than those recommended. Substitution of a fuse of improper rating can cause extensive electrical system damage and possibly a fire.

#### Specified fuses:

Main fuse:	30 A
Headlight fuse:	15 A
Signaling system fuse:	15 A
Ignition fuse:	15 A

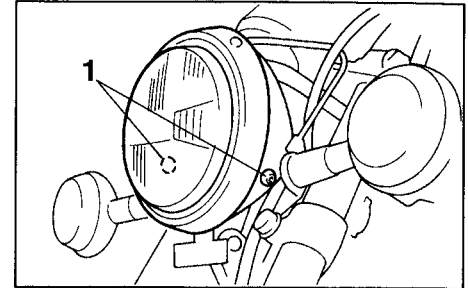

1. Screw (× 2)

EAU01376

## Headlight bulb replacement

EC000107

### CAUTION:

It is advisable to have a Yamaha dealer perform this removal and re-assembly.

If the headlight bulb burns out, replace the bulb as follows:

1. Remove the screws holding the headlight unit.

## PERIODIC MAINTENANCE AND MINOR REPAIR

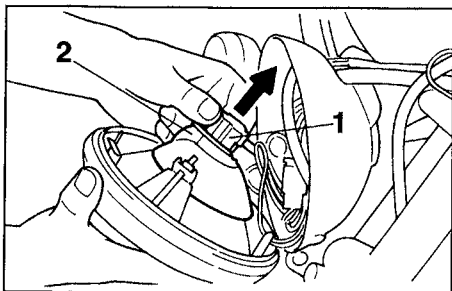

1. Connector
2. Bulb cover

2. Disconnect the connector and remove the bulb holder cover.

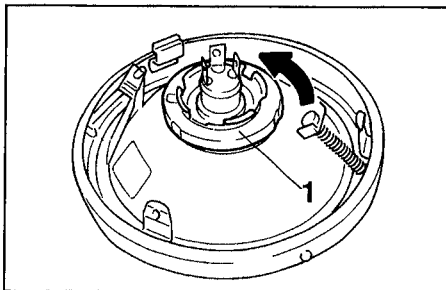

1. Bulb holder

3. Turn the bulb holder counterclockwise to remove it and remove the defective bulb.

EW000120

### **⚠ WARNING**

**Keep flammable products and your hands away from the bulb while it is on, as it is hot. Do not touch the bulb until it cools down.**

4. Put a new bulb into position and secure it in place with the bulb holder.

5. Reinstall the bulb holder cover, connector and headlight unit. If the headlight beam adjustment is necessary, ask a Yamaha dealer to make that adjustment.



# PERIODIC MAINTENANCE AND MINOR REPAIR

EAU01008

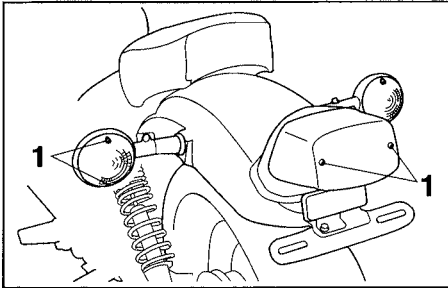

1. Screw (x 2)

EAU00855

## Turn signal and taillight bulb replacement

1. Remove the screws and the lense.

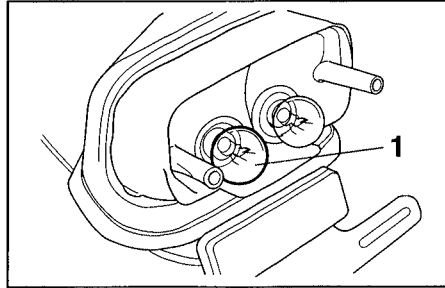

1. Bulb

2. Push the bulb inward and turn it counterclockwise.
3. Place a new bulb in the socket. Push the bulb inward and turn it clockwise until it engages into the socket.
4. Install the lense and the screws.

EC000108

### CAUTION:

**Do not over-tighten the screws as the lense may break.**

## Troubleshooting

Although Yamaha motorcycles receive a rigid inspection before shipment from the factory, trouble may occur during operation.

Any problem in the fuel, compression, or ignition systems can cause poor starting and loss of power. The troubleshooting chart describes a quick, easy procedure for making checks.

If your motorcycle requires any repair, bring it to a Yamaha dealer. The skilled technicians at a Yamaha dealership have the tools, experience, and know-how to properly service your motorcycle. Use only genuine Yamaha parts on your motorcycle. Imitation parts may look like Yamaha parts, but they are often inferior. Consequently, they have a shorter service life and can lead to expensive repair bills.

# PERIODIC MAINTENANCE AND MINOR REPAIR

EAU01297

EW000125

## Troubleshooting chart

### **⚠ WARNING**

**Never check the fuel system while smoking or in the vicinity of an open flame.**

### 1. Fuel

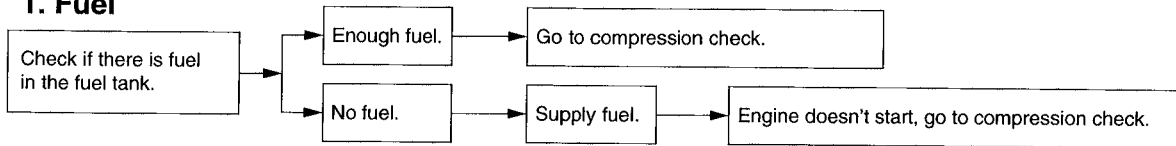

### 2. Compression

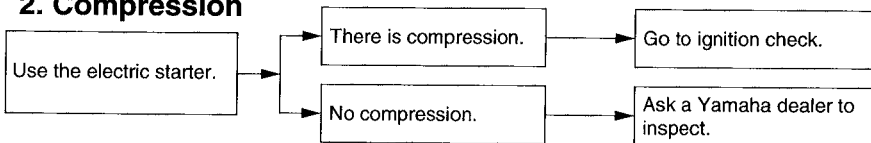

### 3. Ignition

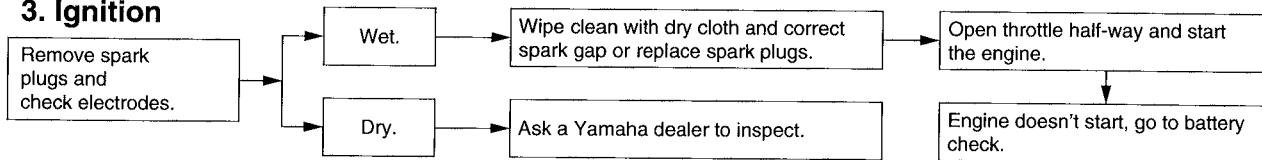

### 4. Battery

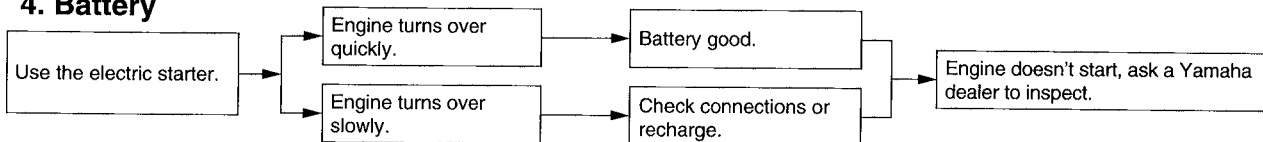

# CLEANING AND STORAGE

Cleaning ..... 7-1  
Storage..... 7-2

EAU01330

## A. CLEANING

Frequent, thorough cleaning of your motorcycle will not only enhance its appearance but will improve its general performance and extend the useful life of many components.

ECA00002

### CAUTION:

---

- **Improper cleaning can damage the cowlings, panels and other plastic parts. Use only a soft, clean cloth or sponge with mild detergent and water to clean plastic.**
  - **Do not use any harsh chemical products on plastic parts. Be sure to avoid using cloths or sponges which have been in contact with strong or abrasive cleaning products, solvent or thinner, fuel (gasoline), rust removers or inhibitors, brake fluid, antifreeze or electrolyte.**
- 

1. Before cleaning the motorcycle:
  - a. Block off the end of the exhaust pipes to prevent water entry; a plastic bag and strong rubber band may be used.
  - b. Make sure the spark plugs and all filler caps are properly installed.
2. If the engine case is excessively greasy, apply degreaser with a paint brush. Do not apply degreaser to wheel axles.
3. Rinse the dirt and degreaser off with a garden hose. Use only enough pressure to do the job.

### CAUTION:

---

**Excessive hose pressure may cause water seepage and deterioration of wheel bearings, front fork, brakes, transmission seals and electrical parts.**

**Many expensive repair bills have resulted from improper high pressure detergent applications such as those available in coin-operated car washers.**

---

4. After riding on salted roads, wash the motorcycle with cold water immediately. Do not use warm water as it increases the chemical reaction of the salt.
5. Once the majority of the dirt has been hosed off, wash all surfaces with warm water and mild, detergent-type soap. An old toothbrush or bottle brush is handy for hard-to-get-at places.

EAU01026

6. Rinse the motorcycle off immediately with clean water and dry all surfaces with a chamois, clean towel or soft absorbent cloth.
7. Clean the seat with a vinyl upholstery cleaner to keep the cover pliable and glossy.
8. Automotive-type wax may be applied to all painted and chrome-plated surfaces. Avoid combination cleaner-waxes. Many contain abrasives which may mar the paint or protective finish. When finished, start the engine and let it idle for several minutes.

## B. STORAGE

Long term storage (60 days or more) of your motorcycle will require some preventive procedures to guard against deterioration. After thoroughly cleaning the motorcycle, prepare for storage as follows:

1. Fill the fuel tank with fuel and add fuel stabilizer (if available).
2. Remove the spark plugs, pour about one tablespoon of engine oil in each spark plug hole and reinstall the spark plugs. Turn the engine over several times (ground spark plug leads) to coat the cylinder walls with oil.

EW000127

### WARNING

**When using the starter motor to crank the engine, remove the spark plug wires, and ground them to prevent sparking.**

3. Lubricate all control cables.
4. Block up the frame to raise both wheels off the ground.
5. Tie a plastic bag over the exhaust pipe outlets to prevent moisture from entering.
6. If storing in a humid or salt-air atmosphere, coat all exposed metal surfaces with a light film of oil. Do not apply oil to any rubber parts or the seat cover.
7. Remove the battery and fully charge it. Store it in a cool, dry place and completely recharge it once a month. Do not store the battery in an excessively warm or cold place (less than 0°C (30°F) or more than 30°C (90°F)). See page 6-28 for battery storage precautions.

### NOTE:

Make any necessary repairs before storing the motorcycle.

Specifications ..... 8-1

## Specifications

<b>Model</b>	<b>XV535/XV535C</b>
<b>Dimensions</b>	
Overall length	2,225 mm (87.6 in)
Overall width	780 mm (30.7 in)
Overall height	1,120 mm (44.1 in)
Seat height	720 mm (28.3 in)
Wheelbase	1,520 mm (59.8 in)
Ground clearance	160 mm (6.3 in)
Minimum turning radius	2,900 mm (114.2 in)
<b>Basic weight (with oil and full fuel tank)</b>	
	195 kg (430 lb): XV535
	196 kg (432 lb): XV535C
<b>Engine</b>	
Engine type	Air-cooled 4-stroke, SOHC
Cylinder arrangement	V type 2-cylinder
Displacement	535 cm <sup>3</sup>
Bore × Stroke	76.0 × 59.0 mm (2.99 × 2.32 in)
Compression ratio	9:1
Starting system	Electric starter
Lubrication system	Wet sump

## Engine oil

Type

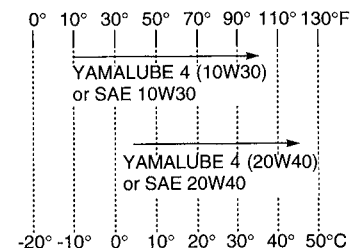

Recommended engine oil classification

API Service SE, SF, SG type or higher

### CAUTION:

**Be sure to use motor oils that do not contain anti-friction modifiers. Passenger car motor oils (often labeled "Energy Conserving") contain anti-friction additives which will cause clutch and/or starter clutch slippage, resulting in reduced component life and poor engine performance.**

Quantity

Periodic oil change	2.6 L (2.3 Imp qt, 2.8 US qt)
With oil filter replacement	2.8 L (2.5 Imp qt, 3.0 US qt)
Total amount	3.2 L (2.8 Imp qt, 3.4 US qt)

## Final gear oil

Type	SAE 80 API "GL-4" hypoid gear oil
Final gear case capacity	0.19 L (0.7 Imp qt, 0.20 US qt)

## Air filter

Dry type element

## Fuel

Type	Regular gasoline
Fuel tank capacity	13.5 L (3.0 Imp gal, 3.6 US gal)
Reserve amount	2.5 L (0.5 Imp gal, 0.7 US gal)

## Carburetor

Type × quantity	BDS34 × 2
Manufacturer	MIKUNI

## Spark plug

Type/Manufacturer	BP7ES / NGK or W22EP-U / DENSO
Gap	0.7 ~ 0.8 mm (0.028 ~ 0.031 in)

## Clutch type

Wet, multiple-disc

## Transmission

Primary reduction system	Spur gear
Primary reduction ratio	1.944
Secondary reduction system	Shaft drive
Secondary reduction ratio	3.071
Transmission type	Constant mesh 5-speed
Operation	Left foot operation

## Gear ratio

1st	2.714
2nd	1.900
3rd	1.458
4th	1.167
5th	0.967

## Chassis

Frame type	Pressed backbone
Caster angle	31.5°
Trail	125 mm (4.92 in)

## Tire

Type	With tube
Size	
Front	3.00-19 49S
Rear	140/90-15M/C 70S
Manufacturer/model	
Front	Bridgestone / L303A Dunlop / F14G
Rear	Bridgestone / G508 Dunlop / K42S
Maximum load	220 kg (485 lb): XV535 219 kg (483 lb): XV535C



# SPECIFICATIONS

## Air pressure (cold tire)

### Up to 90 kg load\*

Front	200 kPa; 2.00 kgf/cm <sup>2</sup> ; 29 psi
Rear	225 kPa; 2.25 kgf/cm <sup>2</sup> ; 33 psi

### 90 kg load ~ maximum load\*

Front	200 kPa; 2.00 kgf/cm <sup>2</sup> ; 29 psi
Rear	250 kPa; 2.50 kgf/cm <sup>2</sup> ; 36 psi

\* Load is total weight of cargo, rider, passenger and accessories.

## Wheels

### Type

Front	Spoke
Rear	Spoke

### Size

Front	19 × MT1.85
Rear	15M/C × MT3.00

## Brakes

### Front

Type	Single disc brake
Operation	Right hand operation
Fluid	DOT 4 or DOT 3

### Rear

Type	Drum brake
Operation	Right foot operation

## Suspension

### Front

Type	Telescopic fork
------	-----------------

### Rear

Type	Swingarm
------	----------

## Shock absorbers

Front	Coil spring / oil damper
-------	--------------------------

Rear	Coil spring / oil damper
------	--------------------------

## Wheel travel

Front	150 mm (5.9 in)
-------	-----------------

Rear	85 mm (3.3 in)
------	----------------

## Electrical system

Ignition system	T.C.I. (digital)
-----------------	------------------

### Charging system

Type	A.C. magneto
Standard output	14 V, 24 A @ 5,000 r/min

### Battery

Type	GM12AZ-3A-2
Voltage, capacity	12 V, 12 AH

## Headlight type

Bulb type

## **Bulb voltage, wattage × quantity**

Headlight	12 V, 65 W / 60 W × 1
Tail/brake light	12 V, 8 W / 27 W × 2
Front flasher / position light	12 V, 27 W / 8 W × 2
Rear flasher light	12 V, 27 W × 2
Meter light	14 V, 3 W × 1
Neutral indicator light	14 V, 3 W × 1
High beam indicator light	12 V, 1.7 W × 1
Turn indicator light	14 V, 3 W × 1

## **Fuses**

Main fuse	30 A
Ignition fuse	15 A
Signaling system fuse	15 A
Headlight fuse	15 A

Identification numbers record.....	9-1
Key identification number.....	9-1
Vehicle identification number .....	9-1
Model label.....	9-2
Reporting safety defects .....	9-3
Motorcycle noise regulation .....	9-4
Maintenance record .....	9-5
Street and enduro motorcycle limited warranty.....	9-7
Yamaha extended service.....	9-9

# CONSUMER INFORMATION

EAU01040

## Identification numbers record

Record the key identification number, vehicle identification number and model label information in the spaces provided for assistance when ordering spare parts from a Yamaha dealer or for reference in case the vehicle is stolen.

1. KEY IDENTIFICATION NUMBER:

2. VEHICLE IDENTIFICATION NUMBER:

3. MODEL LABEL INFORMATION:

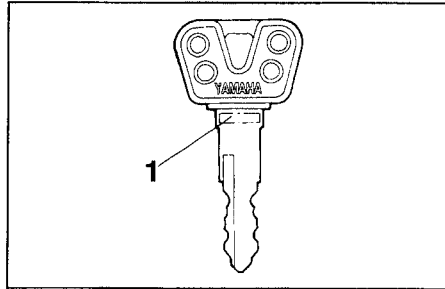
1. Key identification number

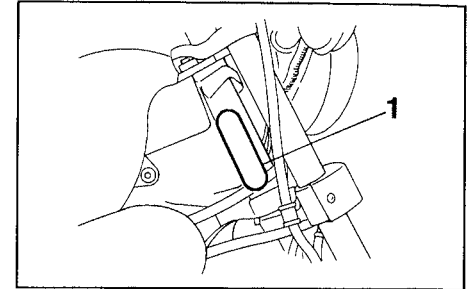

1. Vehicle identification number

EAU01042

## Key identification number

The key identification number is stamped on the key. Record this number in the space provided and use it for reference when obtaining a new key.

EAU01043

## Vehicle identification number

The vehicle identification number is stamped into the steering head pipe. Record this number in the space provided.

### NOTE:

The vehicle identification number is used to identify your motorcycle and may be used to register your motorcycle with the licensing authority in your state.

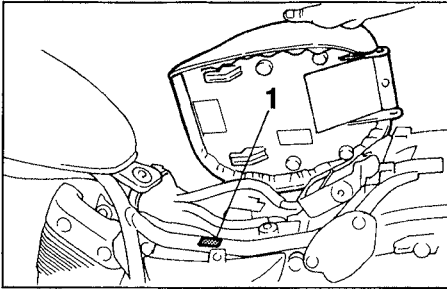

1. Model label

EAU01050

## Model label

The model label is affixed to the frame under the seat. (See page 3-7 for seat removal procedures.) Record the information on this label in the space provided. This information will be needed to order spare parts from your Yamaha dealer.

# CONSUMER INFORMATION

---

EAU01051

## REPORTING SAFETY DEFECTS

If you believe that your vehicle has a defect which could cause a crash or could cause injury or death, you should immediately inform the National Highway Traffic Safety Administration (NHTSA) in addition to notifying YAMAHA MOTOR CORP. U.S.A.. If NHTSA receives similar complaints, it may open an investigation, and if it finds that a safety defect exists in group of vehicles, it may order a recall and remedy campaign. However, NHTSA cannot become involved in individual problems between you, your dealer, or YAMAHA MOTOR CORP. U.S.A..

To contact NHTSA, you may either call the Auto Safety Hotline toll-free at 1-800-424-9393 (or 366-0123 in Washington, D.C. area) or write to: NHTSA, U.S. Department of Transportation, Washington, D.C. 20590. You can also obtain other information about motor vehicle safety from the Hotline.

## MOTORCYCLE NOISE REGULATION

### TAMPERING WITH NOISE CONTROL SYSTEM PROHIBITED:

Federal law prohibits the following acts or the causing thereof: (1) The removal or rendering inoperative by any person other than for purposes of maintenance, repair, or replacement of any device or element of design incorporated into any new vehicle for the purpose of noise control prior to its sale or delivery to the ultimate purchaser or while it is in use or (2) the use of the vehicle after such device or element of design has been removed or rendered inoperative by any person.

“AMONG THOSE ACTS PRESUMED TO CONSTITUTE TAMPERING ARE THE ACTS LISTED BELOW”.

These acts include tampering with the following systems; i.e., modification, removal, etc.

Exhaust system	Muffler Exhaust pipe Silencer
Intake system	Air cleaner case Air cleaner element Intake duct

# CONSUMER INFORMATION

EAU01059

## MAINTENANCE RECORD

Copies of work orders and/or receipts for parts you purchase and install will be required to document that maintenance has been completed in accordance with the emission warranty. The chart below is printed only as a reminder to you that the maintenance work is required. It is not acceptable proof of maintenance work.

MAINTENANCE INTERVAL	DATE OF SERVICE	MILEAGE	SERVICING DEALER NAME AND ADDRESS	REMARKS
1,000km (600mi)or 1 mo.				
7,000km (4,400mi)or 7 mos.				
13,000km (8,200mi)or 13 mos.				
19,000km (12,000mi)or 19 mos.				
25,000km (15,800mi)or 25 mos.				
31,000km (19,600mi)or 31 mos.				
37,000km (23,400mi)or 37 mos.				



# CONSUMER INFORMATION

MAINTENANCE INTERVAL	DATE OF SERVICE	MILEAGE	SERVICING DEALER NAME AND ADDRESS	REMARKS
43,000km (27,200mi)or 43 mos.				
49,000km (31,000mi)or 49 mos.				
55,000km (34,800mi)or 55 mos.				
61,000km (38,600mi)or 61 mos.				

# CONSUMER INFORMATION

EAU01061

## YAMAHA MOTOR CORPORATION, U.S.A. STREET AND ENDURO MOTORCYCLE LIMITED WARRANTY

Yamaha Motor Corporation, U.S.A. hereby warrants each new model Yamaha motorcycle will be free from defects in material and workmanship for the period of time stated herein, subject to certain stated limitations.

**THE PERIOD OF WARRANTY** for Yamaha motorcycles originally equipped with headlight, stoplight, and turn signals shall be one (1) year from the date of purchase, with no mileage limitation.

**MODELS EXCLUDED FROM WARRANTY** include those used for non-Yamaha-authorized renting, leasing, or other commercial purposes, and TZ models.

**DURING THE PERIOD OF WARRANTY** any authorized Yamaha motorcycle dealer will, free of charge, repair or replace any part adjudged defective by Yamaha due to faulty workmanship or material from the factory. Parts used in warranty repairs will be warranted for the balance of the product's warranty period. All parts replaced under warranty become property of Yamaha Motor Corp. U.S.A.

**GENERAL EXCLUSIONS** from this warranty shall include any failures caused by:

- a. Competition or racing use.
- b. Installation of parts or accessories that are not qualitatively equivalent to genuine Yamaha parts.
- c. Abnormal strain, neglect, or abuse.
- d. Lack of proper maintenance.
- e. Accident or collision damage.
- f. Modification to original parts.

**SPECIFIC EXCLUSIONS** from this warranty shall include parts replaced due to normal wear or routine maintenance.

**THE CUSTOMER'S RESPONSIBILITY** under this warranty shall be to:

1. Operate and maintain the motorcycle as specified in the appropriate Owner's Manual, and
2. Give notice to an authorized Yamaha motorcycle dealer of any and all apparent defects within ten (10) days after discovery, and make the machine available at that time for inspection and repairs at such dealer's place of business.

**WARRANTY TRANSFER:** To transfer the warranty from the original purchaser to any subsequent purchaser, it is imperative that the machine be inspected and registered for warranty by an authorized Yamaha motorcycle dealer. In order for this warranty to remain in effect, this inspection and registration must take place within ten (10) days after transfer. An inspection and registration fee will be charged for this service.

### EMISSIONS CONTROL SYSTEM WARRANTY

Yamaha Motor Corporation, U.S.A. also warrants to the ultimate purchaser and each subsequent purchaser of each Yamaha motorcycle covered by this warranty with a displacement of 50cc or greater, that the vehicle is designed, built, and equipped so as to conform at the time of sale with all U.S. emissions standards applicable at the time of manufacture and that it is free from defects in materials and workmanship which would cause it not to meet these standards within the periods listed immediately below. Failure other than those resulting from defects in material or workmanship which arise solely as a result of owner abuse and / or lack of proper maintenance are not covered by this warranty.

ENGINE DISPLACEMENT	PERIOD
50cc to 169cc	12,000 km (7,465 miles) or five years, whichever occurs first
170cc to 279cc	18,000 km (11,185 miles) or five years, whichever occurs first
280cc or over	30,000 km (18,641 miles) or five years, whichever occurs first

**YAMAHA MOTOR CORPORATION, U.S.A. MAKES NO OTHER WARRANTY OF ANY KIND, EXPRESSED OR IMPLIED. ALL IMPLIED WARRANTIES OF MERCHANTABILITY AND FITNESS FOR A PARTICULAR PURPOSE WHICH EXCEED THE OBLIGATIONS AND TIME LIMITS STATED IN THIS WARRANTY ARE HEREBY DISCLAIMED BY YAMAHA MOTOR CORPORATION, U.S.A. AND EXCLUDED FROM THIS WARRANTY.**

**SOME STATES DO NOT ALLOW LIMITATIONS ON HOW LONG AN IMPLIED WARRANTY LASTS. SO THE ABOVE LIMITATION MAY NOT APPLY TO YOU. ALSO EXCLUDED FROM THIS WARRANTY ARE ANY INCIDENTAL OR CONSEQUENTIAL DAMAGES INCLUDING LOSS OF USE. SOME STATES DO NOT ALLOW THE EXCLUSION OR LIMITATION OF INCIDENTAL OR CONSEQUENTIAL DAMAGES, SO THE ABOVE EXCLUSION MAY NOT APPLY TO YOU.**

**THIS WARRANTY GIVES YOU SPECIFIC LEGAL RIGHTS, AND YOU MAY ALSO HAVE OTHER RIGHTS WHICH VARY FROM STATE TO STATE.**

YAMAHA MOTOR CORPORATION, U.S.A.  
P.O. Box 6555  
Cypress, California 90630

## WARRANTY QUESTIONS AND ANSWERS

- Q. What costs are my responsibility during the warranty period?
- A. The customer's responsibility includes all costs of normal maintenance services, non-warranty repairs, accident and collision damages, and oil, oil filters, air filters, spark plugs, and brake shoes.
- Q. What are some examples of "abnormal" strain, neglect, or abuse?
- A. These terms are general and overlap each other in areas. Specific examples include: Running the machine out of oil, sustained high-rpm, full-throttle, operating the machine with a broken or damaged part which causes another part to fail, damage or failure due to improper or careless transportation and or tie down. If you have any specific questions on operation or maintenance, please contact your dealer for advice.
- Q. Does the warranty cover incidental costs such as towing or transportation due to a failure?
- A. No. The warranty is limited to repair of the machine itself.
- Q. May I perform any or all of the recommended maintenance shown in the Owner's Manual instead of having the dealer do them?
- A. Yes, if you are a qualified mechanic and follow the procedures specified in the Owner's and Service Manual. We do recommend, however, that items requiring special tools or equipment be done by Yamaha Motorcycle dealer.
- Q. Will the warranty be void or cancelled if I do not operate or maintain my new motorcycle exactly as specified in the Owner's Manual?
- A. No. The warranty on a new motorcycle cannot be "voided" or "cancelled." **However, if a particular failure is caused by operation or maintenance other than as shown in the Owner's Manual, that failure may not be covered under warranty.**
- Q. What responsibility does my dealer have under this warranty?
- A. Each Yamaha Motorcycle dealer is expected to:
1. Completely set up every new machine before sale.
  2. Explain the operation, maintenance, and warranty requirements to your satisfaction at the time of sale, and upon your request at any later date.
  3. Each Yamaha Motorcycle dealer is held responsible for his setup, service and warranty repair work.
- Q. Is the warranty transferable to second owners?
- A. Yes. The remainder of the existing warranty can be transferred upon request. The unit has to be inspected and re-registered by an authorized Yamaha Motorcycle dealer for the policy to remain effective.

## CUSTOMER SERVICE

If your machine requires warranty service, you must take it to any authorized Yamaha Motorcycle dealer within the continental United States. Be sure to bring your warranty registration card or other valid proof of the original date of purchase. If a question or problem arises regarding warranty, first contact the owner of the dealership. Since all warranty matters are handled at the dealer level, this person is in the best position to help you. If you are still not satisfied and require additional assistance, please write:

YAMAHA MOTOR CORPORATION U.S.A.  
CUSTOMER RELATIONS DEPARTMENT  
P.O. Box 6555  
Cypress, California 90630

When contacting Yamaha Motor Corporation, U.S.A. don't forget to include any important information such as names, addresses, model, V.I.N. (frame number), dates, and receipts.

## CHANGE OF ADDRESS

The federal government requires each manufacturer of a motor vehicle to maintain a complete, up-to-date list of all first purchasers against the possibility of a safety-related defect and recall. This list is compiled from the purchase registrations sent to Yamaha Motor Corporation, U.S.A. by the selling dealer at the time of your purchase.

If you should move after you have purchased your new motorcycle, please advise us of your new address by sending a postcard listing your motorcycle model name, V.I.N. (frame number), dealer number (or dealer's name) as it is shown on your warranty card, your name and new mailing address. Mail to:

YAMAHA MOTOR CORPORATION, U.S.A.  
P.O. Box 6555  
Cypress, California 90630  
Attention: Warranty Department

This will ensure that Yamaha Motor Corporation, U.S.A. has an up-to-date registration record in accordance with federal law.

# CONSUMER INFORMATION

---

EAU01063

## YAMAHA EXTENDED SERVICE (Y.E.S.)

Keep your Yamaha protected even after your warranty expires with genuine Yamaha Extended Service (Y.E.S.).

- Y.E.S. is designed and administered by Yamaha Motor Corporation to provide maximum owner satisfaction. You get uninterrupted factory-backed coverage for extra peace of mind.
- Y.E.S. is flexible. You choose the plan that's right for you: 12 months, 24 months, or 36 months beyond your warranty period.
- Y.E.S. is designed and administered by the same Yamaha people who handle your warranty – and it shows in the comprehensive coverage benefits. There are no mileage limitations. Coverage isn't limited to "moving parts" or the "drive train" like many other plans. And Y.E.S. covers manufacturing defects just like the warranty. See the sample contract at your Yamaha dealer to see how comforting uninterrupted factory-backed protection can be.
- You don't have to pay anything for covered repairs. There's no deductible to pay, and repairs aren't "pro-rated." You don't have any "out-of-pocket" expenses for covered repairs.
- In addition, Travel and Recreation Interruption Protection (TRIP) is included at no extra cost. TRIP gives you up to \$150 reimbursement per occurrence for any reasonable expenses you incur because your Yamaha needs covered service: replacement vehicle rental, emergency towing, phone calls, even food and lodging when you are away from home. This superb coverage goes into effect when you purchase Y.E.S., so it applies to any warranty repairs as well as covered repairs during your entire Y.E.S. plan period.
- Y.E.S. coverage is honored at any authorized Yamaha dealer nationwide.
- Y.E.S. coverage is transferable to a new owner if you sell or trade-in. That can make your Yamaha much more valuable!

This excellent Y.E.S. plan coverage is only available to Yamaha owners like you, and only while your Yamaha is still within the Yamaha Limited Warranty period. So visit your authorized Yamaha dealer to get all the facts. He can show you how easy it is to protect your investment with Yamaha Extended Service.

# CONSUMER INFORMATION

---

We urge you to act now. You'll get the excellent benefits of TRIP coverage right away, and you'll rest easy knowing you'll have strong factory-backed protection even after your Yamaha Limited Warranty expires. You can also save money: Y.E.S. costs less within the first 90 days after you buy your Yamaha. See your dealer today!

A special note:

If visiting your dealer isn't convenient, contact Yamaha with your Primary ID number (your frame number). We'll be happy to help you get the Y.E.S. coverage you need.

Yamaha Service Marketing  
P.O. Box 6555  
Cypress, CA 90630

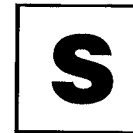

**YAMAHA EXTENDED SERVICE**

# INDEX

- A**  
Accessories or replacement parts .....6-19  
Air filter .....6-13
- B**  
Battery .....6-27  
Brake and clutch lever lubrication .....6-25  
Brake and shift pedal lubrication .....6-25  
Brake fluid replacement .....6-24  
Brake light switch adjustment .....6-22
- C**  
Cable inspection and lubrication .....6-24  
Canister (for California only) .....6-9  
Carburetor adjustment .....6-15  
Checking the front brake pads and rear brake shoes .....6-22  
Cleaning .....7-1  
Clutch lever .....3-3  
Clutch lever free play adjustment .....6-19  
Controls/Instruments .....2-3
- D**  
Dimmer switch .....3-2
- E**  
Engine break-in .....5-6  
Engine oil .....6-10  
Engine stop switch .....3-3
- F**  
Final gear oil .....6-12  
Front brake lever .....3-4  
Front brake lever free play adjustment .....6-20  
Front fork inspection .....6-26  
Fuel .....3-5  
Fuel reserve switch .....3-3  
Fuel tank cap .....3-5  
Fuse replacement .....6-29
- G**  
Gasoline and exhaust gas .....1-5  
General maintenance and lubrication chart .....6-5
- H**  
Handlebar switches .....3-2  
Dimmer switch .....3-2  
Engine stop switch .....3-3  
Fuel reserve switch .....3-3  
Horn switch .....3-2  
Start switch .....3-3  
Turn signal switch .....3-2  
Headlight bulb replacement .....6-29  
Helmet holder .....3-8  
High beam indicator light .....3-1  
Horn switch .....3-2
- I**  
Identification numbers record .....9-1  
Indicator lights .....3-1  
High beam indicator light .....3-1  
Neutral indicator light .....3-1  
Turn indicator light .....3-1  
Inspecting the brake fluid level .....6-23
- K**  
Key identification number .....9-1
- L**  
Left view .....2-1  
Loading and accessories .....1-3  
Location of the important labels .....1-7
- M**  
Main switch .....3-1  
Maintenance record .....9-5  
Model label .....9-2  
Modification .....1-3  
Motorcycle noise regulation .....9-4
- N**  
Neutral indicator light .....3-1
- P**  
Parking .....5-7  
Periodic maintenance .....6-1  
Periodic maintenance chart for emission control system .....6-3

Pre-operation check list .....	4-1
Protective apparel .....	1-2
<b>R</b>	
Rear brake pedal .....	3-4
Rear brake pedal height and free play adjustment .....	6-21
Rear shock absorber adjustment .....	3-9
Recommended shift point .....	5-5
Reporting safety defects .....	9-3
Right view .....	2-2
<b>S</b>	
Safe riding .....	1-1
Seat .....	3-7
Shift pedal .....	3-4
Shifting .....	5-4
Sidestand .....	3-9
Sidestand lubrication .....	6-25
Sidestand/clutch switch operation check .....	3-10
Spark plugs .....	6-8
Specifications .....	8-1
Speedometer .....	3-2
Start switch .....	3-3
Starter (choke) “  \” .....	3-6
Starting a warm engine .....	5-4
Starting and warming up a cold engine .....	5-1
Steering inspection .....	6-26

Steering lock .....	3-7
Storage .....	7-2
Street and enduro motorcycle limited warranty .....	9-7

## T

Throttle cable and grip lubrication .....	6-24
Throttle cable free play inspection .....	6-15
Tires .....	6-16
To decelerate .....	5-5
To start out and accelerate .....	5-5
Tool kit .....	6-1
Troubleshooting .....	6-31
Troubleshooting chart .....	6-32
Turn indicator light .....	3-1
Turn signal and taillight bulb replacement .....	6-31
Turn signal switch .....	3-2

## V

Valve clearance adjustment .....	6-16
Vehicle identification number .....	9-1

## W

Wheel bearings .....	6-27
Wheels .....	6-18

## Y

Yamaha extended service .....	9-9
-------------------------------	-----

***PROTECT YOUR INVESTMENT***  
***Use Genuine YAMAHA Parts And Accessories***

***See your Authorized YAMAHA Dealer for a Genuine YAMAHA  
Service Manual.***

**YAMAHA**  
YAMAHA MOTOR CO., LTD.



LIT-11626-12-28